

EMM20K22B
EMM20K22W

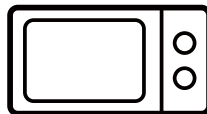

EN Freestanding Microwave Oven

Installation & User manual

2

中文 獨立式微波爐

Installation & User manual

12



Electrolux

WE'RE THINKING OF YOU

Thank you for purchasing an Electrolux appliance. You've chosen a product that brings with it decades of professional experience and innovation. Ingenious and stylish, it has been designed with you in mind. So whenever you use it, you can be safe in the knowledge that you'll get great results every time.

Welcome to Electrolux.

BEFORE USING YOUR APPLIANCE

Check for any damage or marks. If you find the appliance damaged or marked you must report it within 7 days to claim for damages under the manufacturers warranty. This does not affect your statutory rights.

Before you use the appliance, we recommend that you read through the whole user manual which provides the description of the product and its functions. It is important that the product is installed correctly and that you read the safety instructions carefully to avoid misuse and hazards.

For future reference, please store this booklet in a safe place.

CONDITIONS OF USE

This appliance is intended to be used in household and similar applications such as:

- Staff kitchen areas in shops, offices and other working environments.
- Farm houses.
- By clients in hotels, motels and other residential type environments.
- Bed and breakfast type environments.

BEFORE YOU CALL

Please ensure you read the instruction manual fully before you call for service, or a full service fee could be applicable.

RECORD MODEL AND SERIAL NUMBER HERE:

Model: _____

Serial No: _____

IMPORTANT INFORMATION THAT MAY IMPACT YOUR MANUFACTURER'S WARRANTY

Adherence to the directions for use in this manual is extremely important for health and safety. Failure to strictly adhere to the requirements in this manual may result in personal injury, property damage and affect your ability to make a claim under the Electrolux manufacturer's warranty provided with your product. Products must be used, installed and operated in accordance with this manual. You may not be able to claim on the Electrolux manufacturer's warranty in the event that your product fault is due to failure to adhere this manual.

CONTENTS

General warnings	3
Safety instructions	4
Product description.....	5
Accessories	5
Control panel	5
Daily use	6
Using the accessories	8
Helpful hints and tips	8
Care and cleaning	9
Troubleshooting.....	9
Installation.....	10
Electrical Installation.....	11
Customer care center.....	11

SYMBOLS



WARNING!

This symbol indicates information concerning your personal safety.



CAUTION!

This symbol indicates information on how to avoid damaging the appliance.



IMPORTANT!

This symbol indicates tips and information about use of the appliance.



ENVIRONMENT!

This symbol indicates tips and information about economical and ecological use of the appliance.

INFORMATION ON DISPOSAL FOR USERS



ENVIRONMENT!

- Most of the packaging materials are recyclable. Please dispose of these materials through your local recycling depot or by placing them in appropriate collection containers.
- If you wish to discard this product, please contact your local authorities and ask for the correct method of disposal.

GENERAL WARNINGS

Important safety instructions, read carefully and keep for future reference. Pass the user manual on to possible new owners of the appliance.

NOTE! You must read these warnings carefully before installing or using the appliance. If you need assistance, contact your Customer Care Department. The manufacturer will not accept liability, should these instructions or any other safety instructions incorporated in this book be ignored.

Children and vulnerable people safety.



WARNING!

Risk of suffocation, injury or permanent disability.

- This appliance is not intended for use by persons (including children) with reduced physical, sensory or mental capabilities, or lack of experience and knowledge, unless they have been given supervision or instruction concerning use of the appliance by a person responsible for their safety.
- Children should be supervised to ensure that they do not play with the appliance.
- Keep all packaging away from children.
- If the appliance has a child safety device, we recommend that you activate it if children are present.
- WARNING: Accessible parts may become hot during use. Young children should be kept away.



CAUTION!

Important safety instructions, read carefully and keep for future reference.

General safety

- Internally the appliance becomes hot when in operation. Do not touch the heating elements that are in the appliance. Always use oven gloves to remove or put in accessories or ovenware.
- Do not use a steam cleaner to clean the appliance.
- Before maintenance isolate the power supply.
- If the door or door seals are damaged, the appliance must not be operated until it has been repaired by a competent person.
- The appliance is not intended to be operated by means of an external timer or separate remote-control system.
- Only a competent person can carry out any service or repair operation that involves the removal of a cover which gives protection against exposure to microwave energy.
- Do not heat liquids and other foods in sealed containers. They are liable to explode.

- Only use utensils that are suitable for use in microwave ovens.
- When heating food in plastic or paper containers, keep an eye on the appliance due to the possibility of ignition.
- The appliance is intended for heating food and beverages. Drying of food or clothing and heating of warming pads, slippers, sponges, damp cloth and similar may lead to risk of injury, ignition or fire.
- If smoke is emitted, switch off or unplug the appliance and keep the door closed in order to stifle any flames.
- Microwave heating of beverages can result in delayed eruptive boiling. Care must be taken when handling the container.
- The contents of feeding bottles and baby food jars should be stirred or shaken and the temperature checked before consumption, in order to avoid burns.
- Eggs in their shell and whole hard-boiled eggs should not be heated in the appliance since they may explode, even after microwave heating has ended.
- The appliance should be cleaned regularly and any food deposits removed.
- Failure to maintain the appliance in a clean condition could lead to deterioration of the surface that could adversely affect the life of the appliance and possibly result in a hazardous situation.
- The temperature of accessible surfaces may be high when the appliance is operating.
- This appliance is designed for freestanding application. It must not be installed behind a decorative door or installed in an enclosed cupboard. Please follow the installation requirements in this manual.
- Do not use harsh abrasive cleaners or sharp metal scrapers to clean the glass door since they can scratch the surface, which may result in shattering of the glass.
- If the supply cord is damaged, it must be replaced by the manufacturer or an authorised service agent or similarly qualified persons in order to avoid a hazard.



CAUTION!

In order to avoid a hazard due to inadvertent resetting of the thermal cut-out, this appliance must not be supplied through an external switching device, such as a timer, or connected to a circuit that is regularly switched on and off by the utility.



WARNING!

Ensure that the appliance is switched off before replacing the lamp to avoid the possibility of electric shock.

SAFETY INSTRUCTIONS

Installation



WARNING!

Only a qualified person must install this appliance.

- Remove all the packaging.
- Do not install or use a damaged appliance.
- Obey the installation instructions supplied with the appliance.
- Always be careful when you move the appliance because it is heavy. Always wear safety gloves.
- Keep the minimum distance from the other appliances and units.

Electrical connection



WARNING!

Risk of fire and electrical shock.

- This appliance is supplied with a power cord and 10A power plug suitable for connection to standard 10A power socket. If a power socket needs to be installed, it must be done by a suitably qualified electrician.
- The appliance must be earthed.
- Make sure that the electrical information on the rating plate agrees with the power supply. If not, contact an electrician.
- Connect the mains plug to the mains socket only at the end of the installation. Make sure that there is access to the mains plug after the installation.
- Make sure not to cause damage to the mains plug and to the mains cable. Contact the Service Centre or an electrician to change a damaged mains cable.
- Do not pull the mains cable to disconnect the appliance. Always pull the mains plug.

Use



WARNING!

Risk of injury, burns or electric shock or explosion.

- Use this appliance in a household environment.
- Do not change the specification of this appliance.
- Make sure that the ventilation openings are not blocked.
- Do not leave the appliance unattended during operation.
- Do not apply pressure on the open door.
- Do not use the appliance as a work surface and do not use the cavity for storage purposes.
- Do not operate appliance without food.
- Metallic containers for food and beverages are not allowed during microwave cooking.

Care and cleaning



WARNING!

Risk of injury, fire or damage to the appliance.

- Before maintenance, deactivate the appliance and disconnect the mains plug from the mains socket.
- Regularly clean the appliance to prevent the deterioration of the surface material.
- Do not allow food spills or cleaner residue to accumulate on door sealing surfaces.
- Remaining fat or food in the appliance can cause smoke/fire, particularly on the grill element.
- Clean the appliance with a moist soft cloth. Only use neutral detergents. Do not use abrasive products, abrasive cleaning pads, solvents or metal objects.
- Do not use a steam cleaner to clean this appliance.

Disposal



WARNING!

Risk of injury or suffocation.

- Disconnect the appliance from the mains supply.
- Cut off the mains cable and discard it.

PRODUCT DESCRIPTION

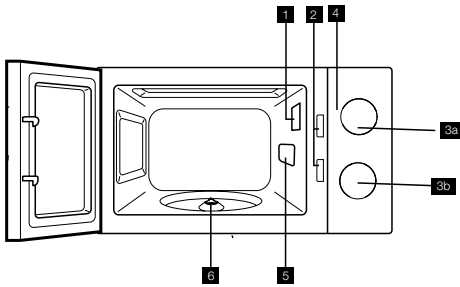

- 1** Lamp
- 2** Safety Interlock system
- 3a** Power level Knob
- 3b** Timer Knob
- 4** Control panel
- 5** Brown mica cover
- 6** Turntable shaft

ACCESSORIES

Turntable set

Glass cooking tray and roller guide.

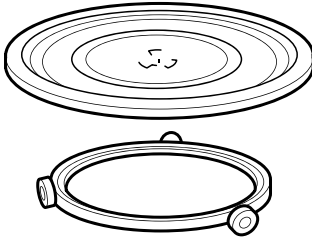

Always use the turntable set to prepare food in the appliance.

CONTROL PANEL

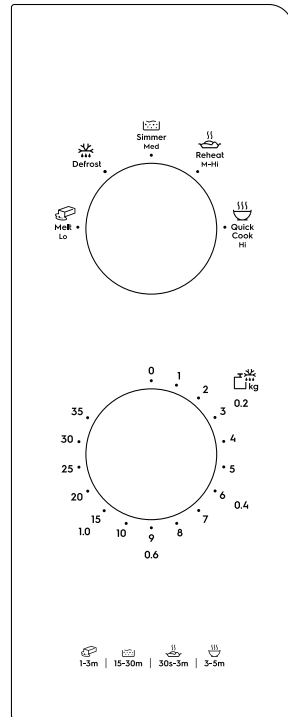

Symbol	Function	Description
1	Quick Cook	Fast or normal cooking.
2	Reheat	Normal cooking. Reheat.
3	Simmer	Slow cooking, simmer and stew.
4	Defrost	To defrost food by time.
5	Melt	Keep warm. Melting/ soften.
6	Weight Defrost	To defrost food by weight.

DAILY USE

Suitable cookware and materials

Cookware / Material	Microwave			Grilling/ Convection
	Defrosting	Heating	Cooking	
Ovenproof glass and porcelain (with no metal components, e.g. Pyrex, heat-proof glass)	■	■	■	■
Non-ovenproof glass and porcelain ¹⁾	■	--	--	--
Glass and glass ceramic made of ovenproof / frost-proof material (e.g. Arcoflam), grill shelf	■	■	■	■
Ceramic ²⁾ , earthenware ²⁾	■	■	■	--
Heat-resistant plastic up to 200°C ³⁾	■	■	■	--
Cardboard, paper	■	--	--	--
Clingfilm	■	--	--	--
Roasting film with microwave safe closure ³⁾	■	■	■	--
Roasting dishes made of metal, e.g. enamel, cast iron	--	--	--	■
Baking tins, black lacquer or silicon coated ³⁾	--	--	--	■
Baking tray	--	--	--	■
Browning cookware, e.g. Crisp pan or Crunch plate	--	■	■	--
Ready meals in packaging ³⁾	■	■	■	■

1) With no silver, gold, platinum or metal plating / decorations.

2) Without quartz or metal components, or glazes which contain metals.





3) You must follow the manufacturer's instructions about the maximum temperatures.

■ suitable

-- not suitable

DAILY USE (CONTINUED)

Power setting tables

Symbol	Power Level	Output (W)	Suitable Foods
	Quick Cook - High	680W	Heat beverage. Cook rice, vegetable & noodles.
	Reheat - Medium High	544W	Cook poultry and meat. Reheat.
	Simmer - Medium	374W	Simmer soup. Stew fish and seafood.
	Defrost - Medium Low	204W	Thaw foods.
	Melt - Low	115.6W	Melt butter/ chocolate. Keep cooked food warm.

Defrosting



1. Turn the knob to Defrost
2. Select suitable time.
Note: If desired time is less than 3 minutes, turn the timer knob to over 3 minutes position and then turn back to the desired time setting.
3. Once the desired time is set, the cooking begins. If pausing in between is needed, just open the door at any time, and close it to resume operation.
4. When it times out and cooking ends, the microwave oven produces a bell ring, the inside lamp will also be automatically turned off.
Note: If food is removed before time out, make sure to set back the timer to "0" position, this avoids the microwave oven from operating in empty load.

Below is some food defrosting time advice:

No.	Weight	Defrost time
1	200g	About 4 minutes
2	400g	About 8 minutes
3	600g	About 12 minutes



Do not use weight defrosting on food that is left out of the freezer for more than 20 minutes, or for frozen ready-made food.

USING THE ACCESSORIES



WARNING!

Refer to the safety chapters.



CAUTION!

Do not cook food without the turntable set. Use only the turntable set provided with the appliance.



Never cook food directly on the glass cooking tray.

Inserting the turntable set

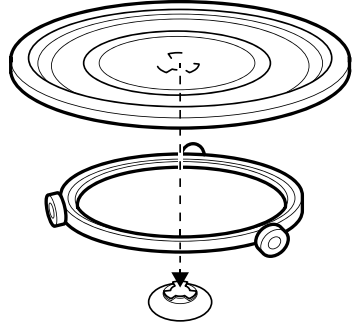

1. Place the roller guide around the turntable shaft.
2. Before first use remove the tape from the centre of the turntable shaft.
3. Place the glass cooking tray on the roller guide.

HELPFUL HINTS AND TIPS

Problem	Remedy
You cannot find details for the amount of food prepared.	Look for a similar food. Increase or shorten the length of the cooking times according to the following rule: Double the amount = almost double the time, Half the amount = half the time
The food got too dry.	Set shorter cooking time or select lower microwave power.
The food is not defrosted, hot or cooked after the time came to an end.	Set longer cooking time or set higher power. Note that large dishes need longer time.
After the cooking time comes to an end, the food is overheated at the edge but is still not ready in the middle.	Next time set a lower power and a longer time. Stir liquids halfway through, e.g. soup.

To get better results for rice use a flat, wide dish.

Defrosting

Always defrost roast with the fat side down. Do not defrost covered meat because this may cause cooking instead of defrosting. Always defrost whole poultry breast side down.

Reheating

When you reheat packed ready meals always follow the instructions written on the packaging.

Cooking

Always remove chilled meat and poultry from the refrigerator at least 30 minutes before cooking. Let the meat, poultry, fish and vegetables stay covered after cooking.

Brush a little oil or melted butter over the fish. Add 30-45ml of cold water for every 250g of vegetables. Cut the fresh vegetables into even size pieces before cooking. Cook all vegetables with a cover on the container.

CARE AND CLEANING



WARNING!

Refer to the safety chapters.

Notes on cleaning:

- To clean front panel fingerprint-resistant stainless steel simply wipe with a soft cloth using warm water and a mild detergent. DO NOT use stainless steel cleaners, abrasive cleaners or harsh solvents.
- Clean the appliance interior after each use. Then you can remove dirt more easily and it does not burn on.
- Clean stubborn dirt with a special cleaner.
- Clean all accessories regularly and let them dry. Use a soft cloth with warm water and a cleaning agent.
- To soften hard to remove remains, boil a glass of water at full microwave power for 2 to 3 minutes.
- To remove odours, mix a glass of water with 2 tsp of lemon juice and boil at full microwave power for 5 minutes.

TROUBLESHOOTING



WARNING!

Refer to the safety chapters.

Problem	Possible cause	Remedy
The appliance does not operate.	The appliance is deactivated.	Activate the appliance.
	The appliance is not plugged in.	Plug in the appliance.
	The fuse in the fuse box is blown.	Check the fuse. If the fuse blows more than one time, contact a qualified electrician.
	The door is not closed properly.	Make sure that nothing blocks the door.
The lamp does not operate.	The lamp is defective.	The lamp has to be replaced. Contact the customer service centre.
	There is sparking in the cavity.	There are metal dishes or dishes with metal trim. Remove the dish from the appliance.
	There are metal skewers or aluminium foil that touches the interior walls.	Make sure that the skewers and foil does not touch the interior walls.
The turntable set makes scratching or grinding noise or does not rotate smoothly.	There is an object or dirt below the glass cooking tray.	Clean the area below the glass cooking tray including rollers. Check turntable roller assembly and glass are installed correctly.
The appliance stops operating without a clear reason.	There is a malfunction.	Check ventilation of the unit is not obstructed. If this situation repeats with correct installation call the customer service centre.
Microwave runs cooking cycle but food does not heat up.	Internal self-resetting thermostat has activated. The microwave is fitted with a thermostat to protect internal components from overheating.	Once the thermostat's temperature has reduced the unit should function normally. Wait 5 minutes then try the appliance again.
Steam accumulating on microwave oven door or leaking from vents.	Cooking foods with a high moisture content will always produce steam.	This is a normal part of the cooking process.
Smoke during cooking process.	Fat accumulated on cavity grill element.	Ensure inside of unit is cleaned regularly.

If you cannot find a solution to the problem yourself, contact your dealer or the customer service centre.

The necessary data for the customer service centre is on the rating plate on the appliance.

We recommend that you write the data here:

Model (M)
.....
Product number (PNC)
.....
Serial number (S.N.)
.....

INSTALLATION



CAUTION!

Do not block the air vents. If you do that, the appliance can overheat.



CAUTION!

Do not connect the appliance to adapters or extension leads. This can cause overloading and risk of fire.

- Put the appliance far away from steam, hot air and water splashes.
- If the appliance is stored/ transported at sub-zero temperatures, do not activate it immediately after installation. Allow at least two hours for it to be brought up to room temperature before turning on the unit.

Installation

- Remove all packing material and any promotional material from the microwave oven.
- Examine the oven for any damage such as dents or a broken door. Do not install if the oven is damaged. Call the service centre.
- Remove the protective film on the oven cabinet surface. Do not remove the light brown Mica cover that is attached to the right-hand side of the oven cavity to protect the magnetron.
- Do not leave the packing material so that small children can play with it. This can be hazardous.
- Select a flat, level surface that provides enough open space for the intake and outlet vents and that is strong enough to bear the weight of the oven. A minimum clearance of 7.5cm is required between the oven and any adjacent walls. Leave a minimum clearance 30cm above the oven.

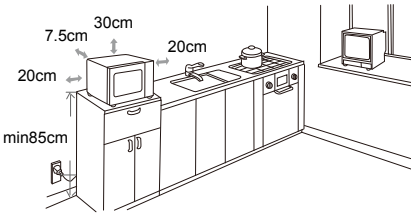

Blocking the intake or outlet vents can damage the oven. If air vents are blocked during operation, the oven may overheat, and this may lead to malfunctioning. Hot air escapes from the vents, so be sure not to obstruct it or let curtains come between the oven and the rear wall.

NOTE: It is recommended to have greater than 7.5cm clearance on at least one of the sides to improve product performance and operation.

- The oven should be placed in a stable position to avoid the possibility of causing vibration or noise.
- Do not remove the legs from the bottom of the oven.
- This oven should only be installed freestanding; not built-in or in a cabinet.
- Keep the oven away from heat and water. Exposure to heat and water can lower the efficiency and lead to malfunctioning.
- Place the oven as far away from radios and TV as possible. Operation of the oven may cause interference to your radio or TV reception.
- When there is interference, it may be reduced or eliminated by taking the following measures:
 - Clean door and sealing surface of the microwave oven.
 - Reorient the receiving antenna of the radio and/or television.
 - Move the microwave oven away from the receiver.
 - Plug the microwave oven into a different outlet so that microwave oven and receiver are on different branch circuits.
- Be sure the voltage and frequency where you connect the microwave oven is the same as specified on the rating plate on the microwave oven. If the microwave oven is connected to the socket via an extension cord, make sure the cord is earthed.



WARNING!

If installed near or over a heat source, the microwave oven could be damaged.



WARNING!

This microwave oven must not be used on a non-earth protected power supply. Contact an electrician if you are uncertain regarding electrical connection of the oven or provision of earth protection of the supply.



WARNING!

If the power cord is damaged, it must be replaced by the manufacturer, its service agent or similarly qualified persons in order to avoid a hazard.

ELECTRICAL INSTALLATION



WARNING!

Only a qualified person must do the electrical installation.



The manufacturer is not responsible if you do not follow the safety precautions from the chapter "Safety Instructions".

This appliance is supplied with a main cable and main plug.



WARNING!

The microwave oven is fitted with a plug and must be only connected to a properly installed, earthed socket. In accordance with the appropriate regulations, the socket must only be installed and the connecting cable must only be replaced by a qualified electrician. If the plug is no longer accessible following installation an all-pole isolating switch must be present on the installation side with a contact gap of at least 3mm.

Customer care center

<p>Thailand Consumer Care Tel : (+66 2) 725 9000 Electrolux Thailand Co., Ltd. Electrolux Building 14th Floor 1910 New Phetchaburi Road, Bangkapi, Huai Khwang, Bangkok 10310 Office Tel : (+66 2) 7259100 Office Fax : (+66 2) 7259299 Email : customercarethai@electrolux.com</p>	<p>Malaysia Consumer Care Center Tel: 1300-88-11-22 Electrolux Home Appliances Sdn. Bhd. Corporate Office Address: Unit T2-7, 7th Floor, Tower 2, PJ33, No. 3, Jalan Semangat, Seksyen 13, 46200 Petaling Jaya, Selangor. Office Tel : (+60 3) 7843 599 9 Office Fax : (+60 3) 7955 5511 Consumer Care Center Address: Lot C6, No. 28, Jalan 15/22, Ta man Perindustrian Tiong Nam, 40200 Shah Alam, Selangor Consumer Care Center Fax : (+60 3) 5524 2521 Email : malaysia.customercare@electrolux.com</p>
<p>Indonesia Hotline service: 08041119999 PT. Electrolux Indonesia Electrolux Building Jl.Abdul Muis No.34, Petojo Selatan, Gambir Jakarta Pusat 10160 Email:customercare@electrolux.co.id SMS & WA : 0812.8088.8863</p>	<p>Philippines Consumer Care Center Toll Free : 1-800-10-845-CARE(2273) Consumer Care Hotline : (+63 2) 845-CARE(2273) Electrolux Philippines, Inc. Unit B 12F Cyber Sigma Bldg, Lawton Avenue, McKinley West, Taguig, Philippines 1634 Trunkline: +63 2 737- 4757 Website : www.electrolux.com.ph Email : wecare@electrolux.com</p>
<p>Vietnam Consumer Care Center Toll Free: 1800-58-88-99 Tel: (+84 28) 3910 5465 Electrolux Vietnam Ltd. Floor 10th, Sofic Tower 10 Mai Chi Tho Street – Thu Thiem Ward – District 2 Thu Duc City, Ho Chi Minh City, Vietnam Office Tel: (+84 28) 3910 5465 Office Fax: (+84 28) 3910 5470 Email: vncare@electrolux.com</p>	<p>Singapore Consumer Care Center Tel: (+65) 6727 3699 Electrolux S.E.A. Pte Ltd. 351 Braddell Road #01-04, 351 On Braddell Singapore 579713 Office Fax : (+65) 6727 3611 Email : customer-care.sin@electrolux.com</p>
<p>Korea Contact Center: 1566-1238 Electrolux Korea Ltd. 9th Floor, Pine Avenue B, 100 Eulji-ro, Jung-gu, Seoul 04551, Korea Electrolux Korea Home page: www.electrolux.co.kr Customer Care Home page: www.electroluxconsumer.co.kr Email: homecare.krh@electrolux.com</p>	<p>Taiwan Consumer Care Center Toll Free: 0800-888-259 Electrolux S.E.A Private Limited Taiwan Branch 4F., No. 3, Sec. 1, Dunhua S. Rd. Songshan Dist., Taipei City 105408 Email: service.tw@electrolux.com</p>

我們為您著想

感謝您購買伊萊克斯電器。您選擇了一款擁有數十年專業經驗和創新的產品。它巧妙而時尚，專為您而設計。無論何時使用，您都盡可放心，因為您每次都會獲得出色效果。歡迎光顧伊萊克斯。

使用設備前

檢查是否有任何損壞痕跡。如果您發現設備損壞或有痕跡，必須在 7 天內報告，以根據製造商的保修要求索賠。這並不影響您的法定權利。

在您使用設備前，我們建議您通讀完整的用戶手冊，其中提供了設備及其功能的描述。正確安裝設備並仔細閱讀安全說明以避免誤用和危險，這非常重要。

請將本手冊存放在安全的地方，以便日後參考。

使用條件

本電器僅限家庭和類似場合應用，例如

- 商店，辦公室和其他工作環境中的員工廚房區域。
- 農舍。
- 酒店、汽車旅館和其他住宅類型環境中的客戶。
- 住宿加早餐型環境。

致電求助之前

請確保您在致電尋求服務前完整閱讀說明手冊，否則可能需要支付全部服務費。

在此處記錄型號和序號：

型號： _____

序列號： _____

可能影響製造商保修的重要資訊

遵守用戶手冊中的使用說明對健康和安全極為重要。未能嚴格遵守用戶手冊中的要求可能會導致人身傷害、財產損失並影響您根據產品隨附的伊萊克斯製造商保修條款提出索賠的權利。必須按照用戶手冊使用、安裝和操作產品。如果由於未遵守本手冊而導致您的產品故障，您可能無法根據伊萊克斯製造商的保修條款提出索賠。

目錄

一般警告	13
安全說明	14
產品描述	15
配件	15
操作介面	15
日常使用	16
使用配件	18
使用提示和技巧	18
保養和清潔	19
故障排除	19
安裝	20
電氣安裝	21
客戶服務中心	21

符號



警告！

此符號表示與您人身安全相關的資訊。



注意！

此符號表示與如何避免損壞設備相關的資訊。



重要！

此符號表示與使用設備相關的提示和資訊。



環境！

此符號表示與設備使用的節能與環保相關的提示和資訊。

用戶對產品處置的資訊



環境！

- 大多數包裝材料可回收。請透過當地的回收站處理這些材料，或將其放入適當的收集箱內。
- 如果您想丟棄該設備，請聯絡與當地相關政府機關，詢問正確的處理方法。

一般警告

重要的安全說明，請仔細閱讀並保存，以備日後參考。如有可能，請將用戶手冊轉交給設備的新主人。

注意！在安裝或使用設備前，您必須仔細閱讀這些警告。如果需要幫助，請聯絡您的客戶服務部門。

如果您忽略這些說明或本書中包含的任何其他安全說明，製造商將不承擔任何責任。

兒童和弱勢群體的安全。



警告！

窒息、受傷或永久殘疾的風險。

- 本設備不適合身體、感官或精神能力下降或缺乏經驗和知識的人（包括兒童）使用，除非他們已由負責其安全的人員對設備的使用進行監督或指導。
- 應該督導兒童，以確保他們不要把本設備當作玩具玩耍。
- 請讓兒童遠離所有包裝。
- 如果設備帶有兒童安全裝置，您應在家中有兒童的情況下啟動該功能。
- 警告：可觸及的零件在使用過程中可能會變熱。幼兒應遠離。



注意！

重要的安全說明，請仔細閱讀並保存，以備日後參考。

一般安全

- 本產品的內部在運行時會變熱。請勿觸摸設備中的加熱零件。始終使用烤箱手套取出或放入配件或烤箱器皿。
- 請勿使用蒸汽清潔器清潔本設備。
- 維護前切斷電源。
- 如果產品的門或閘密封件損壞，必須由合格人員修理後才能操作。
- 本產品不能透過外部計時器或單獨的遠端控制系統進行操作。
- 一些服務或維修操作需要拆除可防止暴露于微波能量的保護罩，僅允許具有相應資格的人員才可進行此操作。
- 不要加熱裝在密封容器中的液體或其他食物，很容易導致爆炸。
- 僅使用適合在微波爐中使用的器皿。

- 在加熱塑膠或紙質容器中的食物時，由於此類器皿可能被點燃，應注意觀察。
- 本設備用於加熱食物和飲料。如果烘乾食物或衣服、加熱保暖墊、拖鞋、海綿、濕布和類似物品可能會導致受傷、灼傷或火災風險。
- 如果本設備冒煙，請立即關閉或拔掉插頭，並保持箱門關閉，扼制火勢蔓延。
- 使用微波加熱飲料可能導致延遲噴發沸騰，因此在移動容器時必須小心。
- 奶瓶和嬰兒食品罐的內容物，在食用前應搖晃或攪拌並檢查溫度，以避免燙傷。
- 帶殼雞蛋和整個煮熟的雞蛋不應在本設備中加熱，因為可能引起雞蛋爆炸。即使在加熱結束後也可能導致延遲破裂噴發。
- 應定期清潔設備並清除任何食物殘留。
- 未能使設備保持潔淨可能會導致其表面劣化，從而對設備的使用壽命產生不利影響，並可能導致危險情況。
- 本設備可觸及表面的溫度在運行過程中可能很高。
- 本設備專為獨立應用而設計，不得將其安裝在裝飾門後面或安裝在封閉的櫥櫃中。請遵循本手冊中的安裝要求。
- 請勿使用粗糙的研磨性清潔劑或鋒利的金屬刮刀清潔玻璃門，因為這樣會刮傷表面，導致玻璃破碎。
- 如果電源線損壞，必須由製造商或授權服務代理商或具備類似資格的人員進行更換，以避免造成危險。



注意！

為避免因不慎重啟熱斷路器而造成的危險，本設備不得透過外部開關設備（如計時器）供電，也不得連接到由公用設施定期打開和關閉的電路。



警告！

確保在更換燈管前關閉本設備，以避免可能引發的觸電。

安全說明

安裝



警告！

僅允許具有資格的人員安裝本設備。

- 移除所有包裝。
- 請勿安裝或使用損壞的設備。
- 遵守隨設備提供的安裝說明。
- 由於設備很重，在移動時一定要小心，務必始終佩戴安全手套。
- 與其他設備和裝置保持距離（不得小於最小允許距離）。

電氣連接



警告！

火災和觸電危險。

- 本設備配有電源線和適用於 10A 電源插座連接標準的 10A 電源插頭。如果需要安裝電源插座，則必須由具備相應資格的電工完成。
- 設備必須接地。
- 確保銘牌上的電氣資訊與電源一致。如果不一致，請聯絡技師。
- 僅在安裝結束時將電源插頭連接到電源插座。確保安裝後可以連接到主電源插頭。
- 確保不要損壞電源插頭和電源線。請聯絡服務中心或技師更換損壞的電源線。
- 請勿透過拉動電源線的方式斷開設備電源，應該始終以拔下插頭的方式斷開。

使用



警告！

受傷、燒傷、觸電或爆炸的危險。

- 僅可在居家環境中使用本設備。
- 請勿更改本設備的規格。
- 確保通風口沒有堵塞。
- 請勿在無人看管的情況下運行該設備。
- 不要對打開的門施加壓力。
- 請勿將本設備用作工作臺面，也請勿將微波爐內部用於儲存物品。
- 不要在沒有放食物的情況下運行本設備。
- 在微波加熱過程中，不允許使用金屬容器盛裝食物和飲料。

維護和清潔



警告！

受傷、火災或損害的危險。

- 維護前，請關閉設備並將電源插頭從電源插座上拔下。
- 定期清潔設備，防止表面材料老化。
- 不要讓食物溢出或清潔劑殘留物積聚在門的密封表面。
- 設備中殘留的脂肪或食物可能會導致冒煙 / 起火，尤其是在烤架配件上。
- 用濕抹布清潔設備。只能使用中性洗滌劑。不要使用研磨性產品、研磨性清潔墊、溶劑或金屬物體清潔。
- 請勿使用蒸汽清潔器清潔設備。

處置



警告！

受傷或窒息的危險。

- 斷開設備的電源。
- 切斷電源線並丟棄。

產品說明

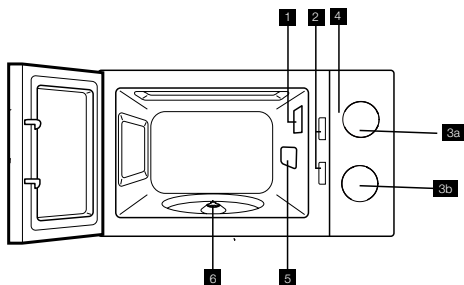

- | | |
|------------------|---------------|
| 1 燈管 | 4 操作介面 |
| 2 安全聯鎖系統 | 5 電波蓋 |
| 3a 功率等級旋鈕 | 6 轉盤軸 |
| 3b 計時器旋鈕 | |

配件

轉盤套裝

玻璃托盤和滾輪導軌。

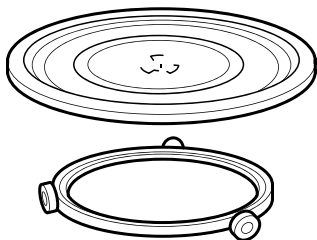

始終使用轉盤套裝在設備中準備食物。

控制台

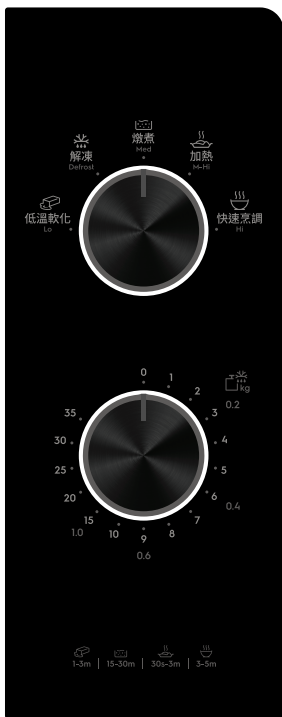

符號	功能	描述
1	快煮	快速或正常烹調。
2	加熱	正常烹調。加熱。
3	燉煮	慢速烹調、燉煮和燜燒。
4	解凍	選擇時間解凍食物。
5	融化	保溫。融化 / 軟化。

日常使用

合適的烹飪用具和材料

烹飪用具 / 材料	微波加熱		燒烤 / 對流
	解凍	烹飪	
耐熱玻璃和瓷器（無金屬成分，例如 Pyrex、耐熱玻璃）	■	■	■
非耐熱玻璃和瓷器 ¹⁾	■	--	--
耐熱 / 防凍材料（例如 Arcoflam）製成的玻璃和玻璃陶瓷、烤架	■	■	■
陶瓷 ²⁾ ，陶器 ²⁾	■	■	--
耐熱塑膠，耐熱溫度最高可達 200° C ³⁾	■	■	--
紙板、紙	■	--	--
保鮮膜	■	--	--
帶微波爐安全封口的烤膜 ³⁾	■	■	--
由金屬製成的烤盤，例如搪瓷、鑄鐵	--	--	■
烤模，黑漆或矽塗層 ³⁾	--	--	■
烤盤	--	--	■
褐變炊具，例如脆鍋或脆盤	--	■	--
包裝中的即食食品 ³⁾	■	■	■

- 1) 沒有銀、金、鉑金或金屬鍍層 / 裝飾。
- 2) 不含石英或金屬成分，或含有金屬的釉料。
- 3) 您必須遵循製造商關於最高溫度的說明。

- 適合
- 不適合

日常使用（續）

功率設置表

符號	功率等級	輸出（瓦）	適合的食物
	快煮 - 高火	680W	熱飲。煮米飯、蔬菜和麵條。
	加熱 - 中高火	544W	烹飪家禽和肉類。加熱。
	燉煮 - 中火	374W	燉湯。燉魚和海鮮。
	解凍 - 中低火	204W	解凍食物。
	融化 - 低火	115.6W	融化黃油 / 巧克力。保溫熟食。

解凍



1. 將旋鈕轉至 Defrost。
2. 選擇合適的時長。

注意：如果所需時間少於 3 分鐘，請將計時器旋鈕轉到 3 分鐘以上的位置，然後再將旋鈕轉回所需時間。

3. 設定所需時間後，即可開始烹飪。如果中途需要暫停，只需要隨時打開門即可，關上門就可以恢復運行。
4. 設定時間結束和烹飪結束時，微波爐會發出提醒音，裡面的燈管也會自動關閉。

注意：如果在設定時間結束前取出食物，一定要將計時器調回“0”，避免微波爐在空載時運行。

食物解凍的建議時間：

編號	重量	解凍時間
1	200 克	約 4 分鐘
2	400 克	約 8 分鐘
3	600 克	約 12 分鐘



不要用重量解凍模式解凍從冰箱中取出超過 20 分鐘的食物或冷凍的現成食物。

使用配件



警告！

請參閱《安全》章節。



注意！

不要在沒有轉盤套裝的情況下烹飪食物。只能使用設備隨附的轉盤套裝。



切勿直接在玻璃托盤上烹飪食物。

插入轉盤套裝

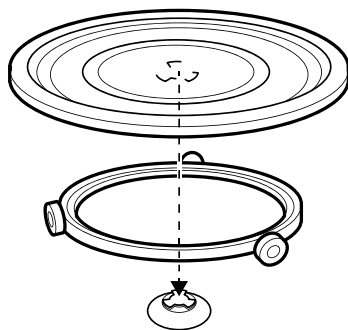

1. 將滾輪導軌放在轉盤軸周圍。
2. 首次使用前，取下轉盤軸中心的膠帶。
3. 將玻璃托盤放在滾輪導軌上。

實用提示和技巧

問題	補救措施
找不到所需製備食物的重量信息。	尋找類似的食物。根據以下規則延長或縮短加熱時間： 雙倍量 = 幾乎雙倍的時間， 一半量 = 一半的時間
食物太乾。	設置較短的加熱時間或選擇較低的微波功率。
時間結束後，食物尚未被解凍、加熱或煮熟。	設置更長的加熱時間或更高的功率。注意，大型菜肴需要更長時間。
加熱時間結束後，食物周圍已經過熱，但中心仍未熟透。	下次設置較低的功率和較長的時間。湯菜等液體性食物可在加熱中途攪拌，以均勻受熱。

為了煮出更好的米飯，請使用扁平寬大的盤子。

解凍

解凍烤肉時，將肥的一面朝下。不要解凍被蓋住的肉，這可能會導致肉被煮熟而不是解凍。解凍整只家禽時，始終保持其胸部朝下。

加熱

加熱預包裝的即食食品時，一定要遵循包裝上的說明。

烹調

烹調前至少提前 30 分鐘把冷藏的肉類和家禽從冰箱裡拿出來。完成烹飪後用器具蓋住肉、家禽、魚和蔬菜。

在魚身上刷一點食用油或融化的黃油。每 250 克蔬菜應加入 30-45 毫升的冷水。烹飪前將新鮮蔬菜切成大小均勻的塊狀。烹飪所有蔬菜時都應在容器上加上蓋子。

保養和清潔



警告!

請參閱安全章節。

清潔注意事項:

- 要清潔前面板的防指紋不銹鋼，只需用軟布蘸溫水配合溫和的清潔劑擦拭即可。請勿使用不銹鋼清潔劑、研磨性清潔劑或刺激性溶劑。

- 每次使用後都應清潔設備內部，這樣您每次都可以很容易地去除污垢並且不會有燃燒風險。
- 使用專用清潔劑清潔頑固污垢。
- 定期清潔所有配件並保持乾燥。用軟布蘸溫水配合清潔劑清潔。
- 在微波爐中放入一杯水，以最大功率煮沸 2-3 分鐘，從而軟化微波爐內部難以清除的殘留物。
- 將一杯水與 2 茶匙檸檬汁混合，以最大功率煮沸 5 分鐘，從而去除微波爐內部的異味。

故障排除



警告!

請參閱安全章節。

問題	可能原因	補救措施
設備不運行。	設備已停用。	啟動設備。
	設備沒有插上插頭。	插上設備插頭。
	保險絲盒中的保險絲熔斷。	檢查保險絲。如果保險絲不止一次熔斷，請聯絡具有資格的電工。
燈管不運行。	門未正確關閉。	確保沒有東西擋住門。
	燈管有問題。	必須更換燈管。請聯絡客戶服務中心。
微波爐內有火花。	放入了金屬盤子或帶金屬飾邊的盤子。取出盤子。	
	有金屬針或鋁箔接觸到內牆。	確保金屬針或箔紙不接觸內壁。
轉盤套裝發出刮擦或磨擦聲或轉動不順暢。	玻璃托盤下方有異物或污垢。	清潔玻璃托盤下方區域，包括滾軸。檢查轉盤滾軸配件和玻璃托盤是否安裝正確。
設備在沒有明確原因的情況下停止運行。	有故障。	檢查設備的通風口是否被阻擋。如果此類情況在設備已正確安裝的情況下重複出現，請致電客戶服務中心。
微波爐迴圈運行烹飪模式，但食物沒有加熱。	內部自動恆溫控制已啟動。微波爐配有恆溫器，以防止內部配件過熱。	恆溫器溫度降低後，設備就會恢復正常運行。等待 5 分鐘，然後再次嘗試運行設備。
蒸汽積聚在微波爐門上或從通風口逸出。	烹飪水分含量高的食物經常會產生蒸汽。	這是烹飪過程中的正常情況。
烹飪過程中冒煙。	油脂堆積在微波爐內的烤架配件上。	確保定期清潔設備內部。

如果您自己無法解決問題，請聯絡您的經銷商或客戶服務中心。

需告知客戶服務中心的必要資料已標注在設備的銘牌上。

我們建議您在此處記錄資料：

型號 (M)

.....

產品編號 (PNC)

.....

序號 (S.N.)

.....

安裝



注意!

切勿堵塞通風口，否則可能導致設備過熱。



注意!

請勿用適配器或延長線連接設備，可能導致超載和火災風險。

- 將設備放在遠離蒸汽、熱氣流和可能濺到水的地方。
- 如果設備在零下溫度中儲存 / 運輸，請勿在安裝後立即啟動設備。在啟動設備之前，應至少等待兩個小時等待其恢復到室溫。

安裝

- 從微波爐中取出所有包裝材料和任何宣傳材料。
- 檢查微波爐是否有任何損壞，例如門有凹陷或破損。如果微波爐已損壞，請勿安裝並立即致電服務中心。
- 移除微波爐表面的保護膜。不要取下貼在微波爐內腔右側用以保護磁控管的電波蓋。
- 請勿將包裝材料留給兒童玩耍，這非常危險。
- 選擇一個水平檯面，為進氣口和出氣口留有足夠的開放空間，並有足夠的強度來承受微波爐的重量。微波爐與任何相鄰的牆壁之間需要有至少 7.5 釐米的間隙。在微波爐上方至少留出 30 釐米的間隙。

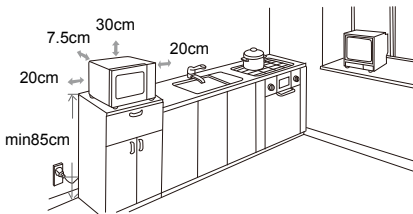

堵塞進氣孔或出氣孔會損壞微波爐。如果在運行過程中堵塞了通風口，微波爐可能會過熱，並可能導致設備故障。熱空氣將從通風口排出，因此務必確保通風口不會被堵塞或窗簾不會卡在微波爐和後牆之間的空間。

注意：建議至少在其中一側留出大於 7.5 釐米的間隙，以提升產品性能和運行效果。

- 微波爐應放置在穩定的位置，避免振動或發出噪音。
- 請勿移除微波爐底部的支腳。
- 本微波爐只能獨立安裝，不能內置安裝或放在櫃子裡。
- 將微波爐放置在遠離熱源和水源的地方。接觸熱源和水源將會降低微波爐的運行效率並引發故障。
- 將微波爐放置在盡可能遠離收音機和電視的地方。運行中的微波爐可能會對收音機或電視的接收造成干擾。
- 可採取以下措施減少或消除干擾：
 - 清潔微波爐的門和密封表面。
 - 調整收音機和 / 或電視的接收天線方向。
 - 把微波爐從接收器旁移開。
 - 將微波爐的插頭插入不同的插座，使微波爐和接收器接在不同的分支電路上。
- 確保連接微波爐的電壓和頻率與微波爐銘牌上的規定相同。如果微波爐是透過延長線連接到插座上，請確保該電線接地。



警告!

如果安裝在熱源附近或上方，微波爐可能會損壞。



警告!

不得在無接地保護的電源上連接本設備。如果您對微波爐的電氣連接或電源的接地保護有疑問，請聯絡技師。



警告!

如果電源線損壞，必須由製造商、其服務代理或具備類似資格的人員更換，以免發生危險。

電氣安裝



警告!

僅允許具有資格的人員進行電氣安裝。



如果您不遵守《安全說明》一章中的安全預防措施，對此造成的後果製造商概不負責。

本設備配有主電線和主插頭。



警告!

本微波爐已配備一個插頭，且只能連接到正確安裝的接地插座。根據相應的規定，僅允許具有資格的電工安裝插座並更換連接電線。如果在安裝後無法再接觸到插頭，則必須在安裝側安裝一個全點擊隔離開關，觸點間隙至少為3mm。

客戶服務中心

<p>泰國</p> <p>Consumer Care Tel : (+66 2) 725 9000 Electrolux Thailand Co., Ltd. Electrolux Building 14th Floor 1910 New Phetchaburi Road, Bangkapi, Huai Khwang, Bangkok 10310 Office Tel : (+66 2) 7259100 Office Fax : (+66 2) 7259299 Email : customercaethai@electrolux.com</p>	<p>馬來西亞</p> <p>Consumer Care Center Tel: 1300-88-11-22 Electrolux Home Appliances Sdn. Bhd. Corporate Office Address: Unit T2-7, 7th Floor, Tower 2, PJ33, No. 3, Jalan Semangat, Seksyen 13, 46200 Petaling Jaya, Selangor. Office Tel : (+60 3) 7843 599 9 Office Fax : (+60 3) 7955 5511 Consumer Care Center Address: Lot C6, No. 28, Jalan 15/22, Ta man Perindustrian Tiong Nam, 40200 Shah Alam, Selangor Consumer Care Center Fax : (+60 3) 5524 2521 Email : malaysia.customercare@electrolux.com</p>
<p>印度尼西亞</p> <p>Hotline service: 08041119999 PT. Electrolux Indonesia Electrolux Building Jl.Abdul Muis No.34, Petojo Selatan, Gambir Jakarta Pusat 10160 Email:customercare@electrolux.co.id SMS & WA : 0812.8088.8863</p>	<p>菲律賓</p> <p>Consumer Care Center Toll Free : 1-800-10-845-CARE(2273) Consumer Care Hotline : (+63 2) 845-CARE(2273) Electrolux Philippines, Inc. Unit B 12F Cyber Sigma Bldg, Lawton Avenue, McKinley West, Taguig, Philippines 1634 Trunkline: +63 2 737- 4757 Website : www.electrolux.com.ph Email : wecare@electrolux.com</p>
<p>越南</p> <p>Consumer Care Center Toll Free: 1800-58-88-99 Tel: (+8428) 3910 5465 Electrolux Vietnam Ltd. Floor 10th, Sofic Tower 10 Mai Chi Tho Street – Thu Thiem Ward – District 2 Thu Duc City, Ho Chi Minh City, Vietnam Office Tel: (+84 28) 3910 5465 Office Fax: (+84 28) 3910 5470 Email: vncare@electrolux.com</p>	<p>新加坡</p> <p>Consumer Care Center Tel: (+65) 6727 3699 Electrolux S.E.A. Pte Ltd. 351 Braddell Road #01-04, 351 On Braddell Singapore 579713 Office Fax : (+65) 6727 3611 Email : customer-care.sin@electrolux.com</p>
<p>韓國</p> <p>Contact Center: 1566-1238 Electrolux Korea Ltd. 9th Floor, Pine Avenue B, 100 Eulji-ro, Jung-gu, Seoul 04551, Korea Electrolux Korea Home page: www.electrolux.co.kr Customer Care Home page: www.electroluxconsumer.co.kr Email: homecare.krh@electrolux.com</p>	<p>台灣</p> <p>Consumer Care Center Toll Free: 0800-888-259 Electrolux S.E.A Private Limited Taiwan Branch 4F., No.3, Sec. 1, Dunhua S. Rd. Songshan Dist., Taipei City 105408 Email: service.tw@electrolux.com</p>

有鑒於世界各國對綠色環保意識的重視，伊萊克斯依循RoHS「危害性限制物質指令」
誠實標示產品化學物質含量，關於本產品的RoHS聲明書，請上伊萊克斯官網-->「支援服務」-->「RoHS聲明書」
依產品類別及型號檢。
<http://www.electrolux.com.tw/Support/Customer-Care/>

www.electrolux.com/shop

