

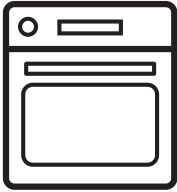

Electrolux



EN User Manual | **Oven**

KOH2H00BK

WE'RE THINKING OF YOU

Thank you for purchasing an Electrolux appliance. You've chosen a product that brings with it decades of professional experience and innovation. Ingenious and stylish, it has been designed with you in mind. So whenever you use it, you can be safe in the knowledge that you'll get great results every time.

Welcome to Electrolux.

Visit our website to:



Get usage advice, brochures, trouble shooter, service and repair information:
www.electrolux.com/support



Register your product for better service:
www.registerelectrolux.com



Buy Accessories, Consumables and Original spare parts for your appliance:
www.electrolux.com/shop

CUSTOMER CARE AND SERVICE

Always use original spare parts.

When contacting our Authorised Service Centre, ensure that you have the following data available: Model, PNC, Serial Number.

The information can be found on the rating plate.

 Warning / Caution-Safety information

 General information and tips

 Environmental information

Subject to change without notice.

CONTENTS

1. SAFETY INFORMATION.....	3
2. SAFETY INSTRUCTIONS.....	4
3. INSTALLATION.....	7
4. PRODUCT DESCRIPTION.....	8
5. BEFORE FIRST USE.....	8
6. DAILY USE.....	9
7. CLOCK FUNCTIONS.....	10
8. USING THE ACCESSORIES.....	10
9. ADDITIONAL FUNCTIONS.....	11
10. HINTS AND TIPS.....	11
11. CARE AND CLEANING.....	14
12. TROUBLESHOOTING.....	17
13. ENERGY EFFICIENCY.....	18
14. SERVICE AND GUARANTEE IN TAIWAN.....	18
15. ENVIRONMENTAL CONCERNS.....	19

1. ⚠ SAFETY INFORMATION

Before the installation and use of the appliance, carefully read the supplied instructions. The manufacturer is not responsible for any injuries or damage that are the result of incorrect installation or usage. Always keep the instructions in a safe and accessible location for future reference.

1.1 Children and vulnerable people safety

- This appliance is not intended for use by persons (including children) with reduced physical, sensory or mental capabilities, or lack of experience and knowledge, unless they have been given supervision or instruction concerning use of the appliance by a person responsible for their safety.
- Children should be supervised to ensure that they do not play with the appliance.
- Keep all packaging away from children and dispose of it appropriately.
- **WARNING:** The appliance and its accessible parts become hot during use. Keep children and pets away from the appliance when in use and when cooling down.
- If the appliance has a child safety device, it should be activated.
- Children shall not carry out cleaning and user maintenance of the appliance without supervision.

1.2 General Safety

- This appliance is for cooking purposes only.
- This appliance is designed for single household domestic use in an indoor environment.
- This appliance may be used in, offices, hotel guest rooms, bed & breakfast guest rooms, farm guest houses and other similar accommodation where such use does not exceed (average) domestic usage levels.

- Only a qualified person must install this appliance and replace the cable.
- Do not use the appliance before installing it in the built-in structure.
- Disconnect the appliance from the power supply before carrying out any maintenance.
- If the supply cord is damaged, it must be replaced by the manufacturer, its Authorised Service Centre or similarly qualified persons to avoid an electrical hazard.
- **WARNING:** Ensure that the appliance is switched off before replacing the lamp to avoid the possibility of electric shock.
- **WARNING:** The appliance and its accessible parts become hot during use. Care should be taken to avoid touching heating elements or the surface of the appliance cavity.
- Always use oven gloves to remove or insert accessories or ovenware.
- To remove the shelf supports first pull the front of the shelf support and then the rear end away from the side walls. Install the shelf supports in the opposite sequence.
- Do not use a steam cleaner to clean the appliance.
- Do not use harsh abrasive cleaners or sharp metal scrapers to clean the glass door since they can scratch the surface, which may result in shattering of the glass.

2. SAFETY INSTRUCTIONS

2.1 Installation

 **WARNING!**

Only a qualified person must install this appliance.

- Remove all the packaging.
 - Do not install or use a damaged appliance.
 - Follow the installation instructions supplied with the appliance.
 - Always take care when moving the appliance as it is heavy. Always use safety gloves and enclosed footwear.
 - Do not pull the appliance by the handle.
- Install the appliance in a safe and suitable place that meets installation requirements.
 - Keep the minimum distance from other appliances and units.
 - Before mounting the appliance, check if the appliance door opens without restraint.
 - The appliance is equipped with an electric cooling system. It must be operated with the electric power supply.

Cabinet minimum height (Cabinet under the worktop minimum height)	590 (600) mm
---	--------------

Cabinet width	560 mm
---------------	--------

Cabinet depth	550 (550) mm
Height of the front of the appliance	598 mm
Height of the back of the appliance	579 mm
Width of the front of the appliance	594 mm
Width of the back of the appliance	558 mm
Depth of the appliance	561 mm
Built in depth of the appliance	540 mm
Depth with open door	1007 mm
Ventilation opening minimum size. Opening placed on the bottom rear side	560x20 mm
Mains supply cable length. Cable is placed in the right corner of the back side	1100 mm
Mounting screws	4x25 mm

2.2 Electrical connection

WARNING!

Risk of fire and electric shock.

- All electrical connections should be made by a qualified electrician.
- The appliance must be earthed.
- Make sure that the parameters on the rating plate are compatible with the electrical ratings of the mains power supply.
- Always use a correctly installed shockproof socket.
- Do not use multi-plug adapters and extension cables.
- Make sure not to cause damage to the mains plug and to the mains cable. Should the mains cable need to be replaced, this must be carried out by our Authorised Service Centre.
- Do not let mains cables touch or come near the appliance door or the niche below the appliance, especially when it operates or the door is hot.

- The shock protection of live and insulated parts must be fastened in such a way that it cannot be removed without tools.
- Connect the mains plug to the mains socket only at the end of the installation. Make sure that there is access to the mains plug after the installation.
- If the mains socket is loose, do not connect the mains plug.
- Do not pull the mains cable to disconnect the appliance. Always pull the mains plug.
- Use only correct isolation devices: line protecting cut-outs, fuses (screw type fuses removed from the holder), earth leakage trips and contactors.
- The electrical installation must have an isolation device which lets you disconnect the appliance from the mains at all poles. The isolation device must have a contact opening width of minimum 3 mm.
- This appliance is supplied only with a main cable.

Cable types applicable for installation or replacement for Europe:

H07 RN-F, H05 RN-F, H05 RRF, H05 VV-F, H05 V2V2-F (T90), H05 BB-F

For the section of the cable refer to the total power on the rating plate. You can also refer to the table:

Total power (W)	Section of the cable (mm ²)
maximum 1380	3x0.75
maximum 2300	3x1
maximum 3680	3x1.5

The earth cord (green / yellow cable) must be 2 cm longer than the brown phase and blue neutral cables.

2.3 Use

WARNING!

Risk of injury, burns and electric shock or explosion.

- Do not change the specification of this appliance.

- Make sure that the ventilation openings are not blocked.
- Do not let the appliance stay unattended during operation.
- Deactivate the appliance after each use.
- Be careful when you open the appliance door while the appliance is in operation. Hot air can release.
- Do not operate the appliance with wet hands or when it has contact with water.
- Do not apply pressure on the open door.
- Do not use the appliance as a work surface or as a storage surface.
- Open the appliance door carefully. The use of ingredients with alcohol can cause a mixture of alcohol and air.
- Do not let sparks or open flames to come in contact with the appliance when you open the door.
- Do not put flammable products or items that are wet with flammable products in, near or on the appliance.

⚠ WARNING!

Risk of damage to the appliance.

- To prevent damage or discoloration to the enamel:
 - do not put ovenware or other objects in the appliance directly on the bottom.
 - do not put aluminium foil directly on the bottom of cavity of the appliance.
 - do not put water directly into the hot appliance.
 - do not keep moist dishes and food in the appliance after you finish the cooking.
 - be careful when you remove or install the accessories.
- Discoloration of the enamel or stainless steel has no effect on the performance of the appliance.
- Use a deep pan for moist cakes. Fruit juices cause stains that can be permanent.
- Always cook with the appliance door closed.
- If the appliance is installed behind a furniture panel (e.g. a door) make sure the door is never closed when the appliance operates. Heat and moisture can build up behind a closed furniture panel and cause subsequent damage to the appliance, the housing unit or the floor. Do not close the

furniture panel until the appliance has cooled down completely after use.

2.4 Care and cleaning

⚠ WARNING!

Risk of injury, fire, or damage to the appliance.

- Before maintenance, deactivate the appliance and disconnect the mains plug from the mains socket.
- Make sure the appliance is cold. There is the risk that the glass panels can break.
- Replace immediately the door glass panels when they are damaged. Contact the Authorised Service Centre.
- Be careful when you remove the door from the appliance. The door is heavy!
- Clean regularly the appliance to prevent the deterioration of the surface material.
- Clean the appliance with a moist soft cloth. Use only neutral detergents. Do not use abrasive products, abrasive cleaning pads, solvents or metal objects.
- If you use an oven spray, follow the safety instructions on its packaging.

2.5 Internal lighting

⚠ WARNING!

Risk of electric shock.

- Concerning the lamp(s) inside this product and spare part lamps sold separately: These lamps are intended to withstand extreme physical conditions in household appliances, such as temperature, vibration, humidity, or are intended to signal information about the operational status of the appliance. They are not intended to be used in other applications and are not suitable for household room illumination.
- Use only lamps with the same specifications.

2.6 Service

- To repair the appliance contact the Authorised Service Centre.
- Use original spare parts only.

2.7 Disposal

WARNING!

Risk of injury or suffocation.

- For information on how to dispose of the appliance, contact your dealer, manufacturer's authorized person, or your local solid waste operator.

- Disconnect the appliance from the mains supply.
- Cut off the mains electrical cable close to the appliance and dispose of it.
- Remove the door catch to prevent children or pets from becoming trapped in the appliance.

3. INSTALLATION

WARNING!

Refer to Safety chapters.

3.1 Building in

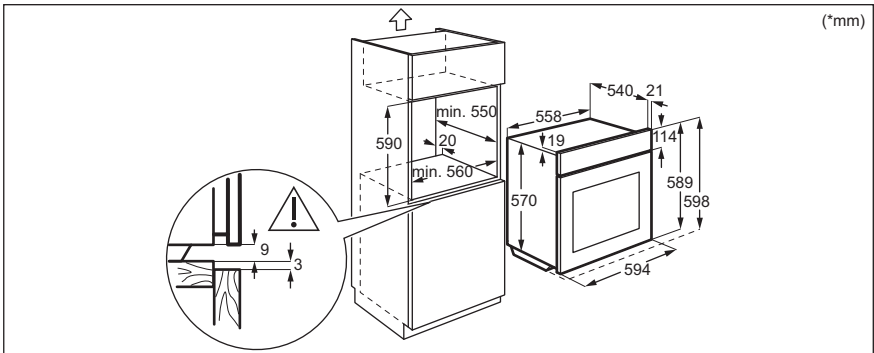
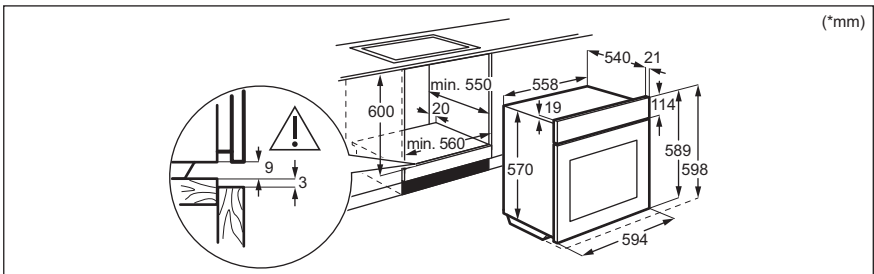

3.2 Securing the oven to the cabinet

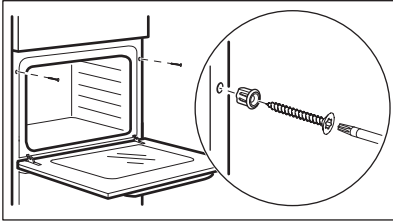

4. PRODUCT DESCRIPTION

4.1 General overview

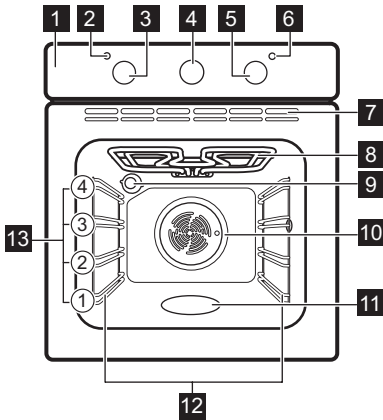

- 1 Control panel
- 2 Power lamp / symbol
- 3 Knob for the heating functions
- 4 Knob for the timer
- 5 Control knob (for the temperature)
- 6 Temperature indicator / symbol
- 7 Air vents for the cooling fan
- 8 Heating element
- 9 Lamp
- 10 Fan
- 11 Cavity embossment - Aqua cleaning container
- 12 Shelf support, removable
- 13 Shelf positions

4.2 Accessories

- **Wire shelf**
For cookware, cake tins, roasts.
- **Grill- / Roasting pan**
To bake and roast or as pan to collect fat.

5. BEFORE FIRST USE

WARNING!

Refer to Safety chapters.

5.1 Before first use

The oven can emit an odour and smoke during preheating. Make sure that the room is ventilated.



Step 1



Clean the oven

1. Remove all accessories and removable shelf supports from the oven.
2. Clean the oven and the accessories only with a microfibre cloth, warm water and a mild detergent.



Step 2

Preheat the empty oven

1. Set the maximum temperature for the function:  Time: 1 h.
2. Set the maximum temperature for the function:  Time: 15 min.

Turn off the oven and wait until it is cold. Place the accessories and the removable shelf supports in the oven.

6. DAILY USE





WARNING!





Refer to Safety chapters.

6.1 How to set: Heating function

- | | |
|---------------|---|
| Step 1 | Turn the knob for the heating functions to select a heating function. |
| Step 2 | Turn the control knob to select the temperature. |
| Step 3 | When the cooking ends, turn the knobs to the off position to turn off the oven. |

6.2 Heating functions

Heating function	Application
 Off position	The oven is off.
 Fan Cooking	To roast or roast and bake food with the same cooking temperature on more than one shelf position, without flavour transference.
 Turbo Grilling	To roast large meat joints or poultry with bones on one shelf position. To make gratins and to brown.
 Bottom Heat	To bake cakes with crispy bottom and to preserve food.

Heating function	Application
 Conventional Cooking / Aqua Clean	To bake and roast food on one shelf position. Refer to "Care and cleaning" chapter for more information about: Aqua Clean.
 Grill	To grill thin pieces of food and to toast bread.
 Defrost	To defrost food (vegetables and fruit). The defrosting time depends on the amount and size of the frozen food.
 Moist Fan Baking	This function is designed to save energy during cooking. When you use this function, the temperature in the cavity may differ from the set temperature. The heating power may be reduced. For more information refer to "Daily Use" chapter, Notes on: Moist Fan Baking.

6.3 Notes on: Moist Fan Baking

This function was used to comply with the energy efficiency class and ecodesign requirements (according to EU 65/2014 and EU 66/2014). Tests according to: IEC/EN 60350-1.

The oven door should be closed during cooking so that the function is not interrupted and the oven operates with the highest energy efficiency possible.

For the cooking instructions refer to "Hints and tips" chapter, Moist Fan Baking. For general energy saving recommendations

refer to "Energy Efficiency" chapter, Energy Saving.

7. CLOCK FUNCTIONS

7.1 How to set: End of Cooking

To set the switch-off time for oven functions.

-
- Step 1** Set the oven function and the temperature.
-
- Step 2** Turn the knob for the timer to its full range.
-
- Step 3** Turn the knob for the timer to set the switch-off time.
When the set time ends, the signal sounds and the oven turns off.
-
- Step 4** Turn the knob for the oven functions and the knob for the temperature to the off position.
-

i To set a heating function without a set cooking time, turn the knob for the timer to the initial position.

8. USING THE ACCESSORIES

⚠ WARNING!

Refer to Safety chapters.

8.1 Inserting accessories

A small indentation at the top increases safety. The indentations are also anti-tip

devices. The high rim around the shelf prevents cookware from slipping of the shelf.

Wire shelf:

Push the shelf between the guide bars of the shelf support and make sure that the feet point down.

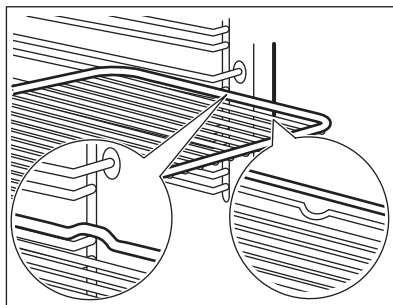

Deep pan:

Push the tray between the guide bars of the shelf support.

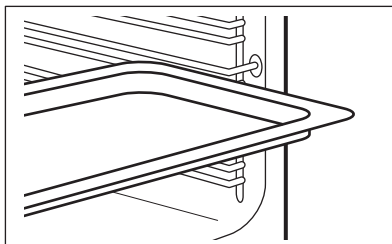

9. ADDITIONAL FUNCTIONS

9.1 Cooling fan

When the appliance operates, the cooling fan turns on automatically to keep the surfaces of the appliance cool. If you turn off the appliance, the cooling fan stops.

9.2 Safety thermostat

Incorrect operation of the oven or defective components can cause dangerous overheating. To prevent this, the oven has a safety thermostat which interrupts the power supply. The oven turns on again automatically when the temperature drops.

10. HINTS AND TIPS



Refer to Safety chapters.

10.1 Cooking recommendations

The oven has four shelf positions.

Count the shelf positions from the bottom of the oven floor.

Your oven may bake or roast differently to the oven you had before.

Baking cakes

Do not open the oven door before 3/4 of the set cooking time is up.

If you use two baking trays at the same time, keep one empty level between them.

Cooking meat and fish

Use a deep pan for very fatty food to prevent the oven from stains that can be permanent.

Leave the meat for approximately 15 minutes before carving so that the juice does not seep out.

To prevent too much smoke in the oven during roasting, add some water into the deep pan. To prevent the smoke condensation, add water each time after it dries up.

Cooking times

Cooking times depend on the type of food, its consistency, and volume.

Initially, monitor the performance when you cook. Find the best settings (heat setting, cooking time, etc.) for your cookware, recipes and quantities when you use this appliance.

10.2 Moist Fan Baking - recommended accessories

Use the dark and non-reflective tins and containers. They have better heat absorption than the light colour and reflective dishes.



Pizza pan

Dark, non-reflective
28 cm diameter

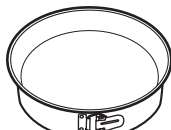

Baking dish

Dark, non-reflective
26 cm diameter



Ramekins

Ceramic
8 cm diameter, 5
cm height













Flan base tin

Dark, non-reflective
28 cm diameter

10.3 Moist Fan Baking







For the best results follow suggestions listed in the table below.







		 (°C)		 (min)
Sweet rolls, 12 pieces	baking tray or dripping pan	180	2	35 - 40
Rolls, 9 pieces	baking tray or dripping pan	180	2	35 - 40
Pizza, frozen, 0.35 kg	wire shelf	220	2	35 - 40
Swiss roll	baking tray or dripping pan	170	2	30 - 40
Brownie	baking tray or dripping pan	180	2	30 - 40
Soufflé, 6 pieces	ceramic ramekins on wire shelf	200	3	30 - 40
Sponge flan base	flan base tin on wire shelf	170	2	20 - 30
Victoria sandwich	baking dish on wire shelf	170	2	35 - 45
Poached fish, 0.3 kg	baking tray or dripping pan	180	3	35 - 45
Whole fish, 0.2 kg	baking tray or dripping pan	180	3	35 - 45
Fish fillet, 0.3 kg	pizza pan on wire shelf	180	3	35 - 45
Poached meat, 0.25 kg	baking tray or dripping pan	200	3	40 - 50
Shashlik, 0.5 kg	baking tray or dripping pan	200	3	25 - 35
Cookies, 16 pieces	baking tray or dripping pan	180	2	20 - 30
Macaroons, 20 pieces	baking tray or dripping pan	180	2	40 - 45
Muffins, 12 pieces	baking tray or dripping pan	170	2	30 - 40
Savory pastry, 16 pieces	baking tray or dripping pan	170	2	35 - 45
Short crust biscuits, 20 pieces	baking tray or dripping pan	150	2	40 - 50

		 (°C)		 (min)
Tartlets, 8 pieces	baking tray or dripping pan	170	2	20 - 30
Vegetables, poached, 0.4 kg	baking tray or dripping pan	180	3	35 - 40
Vegetarian omelette	pizza pan on wire shelf	200	3	30 - 45
Mediterranean vegetables, 0.7 kg	baking tray or dripping pan	180	4	35 - 40

10.4 Information for test institutes

Tests according to IEC 60350-1.

				 (°C)	 (min)	
Small cakes, 16 per tray	Conventional Cooking	Baking tray	3	170	20 - 35	-
Small cakes, 16 per tray	Fan Cooking	Baking tray	3	160	20 - 35	-
Small cakes, 16 per tray	Fan Cooking	Baking tray	1 and 3	160	20 - 35	-
Apple pie, 2 tins Ø20 cm	Conventional Cooking	Wire shelf	1	170	70 - 90	-
Apple pie, 2 tins Ø20 cm	Fan Cooking	Wire shelf	2	160	70 - 90	-
Sponge cake, cake mould Ø26 cm	Conventional Cooking	Wire shelf	2	170	35 - 45	-
Sponge cake, cake mould Ø26 cm	Fan Cooking	Wire shelf	2	160	35 - 45	-
Short bread	Conventional Cooking	Baking tray	3	150	20 - 35	Preheat the oven for 10 min.
Short bread	Fan Cooking	Baking tray	3	150	20 - 35	Preheat the oven for 10 min.
Toast	Grill	Wire shelf	3	max.	1 - 5	Preheat the oven for 10 min.

				 (°C)	 (min)	
Beef burger, 6 pieces, 0.6 kg	Grill	Wire shelf and dripping pan	3	max.	20 - 30	Put the wire shelf on the third level and the dripping pan on the second level of the oven. Turn the food halfway through the cooking time. Preheat the oven for 10 min.

11. CARE AND CLEANING

WARNING!

Refer to Safety chapters.

11.1 Notes on cleaning



Cleaning Agents

Clean the front of the appliance only with a microfibre cloth with warm water and a mild detergent. Clean and check the door gasket around the frame of the cavity.

Use a cleaning solution to clean metal surfaces.

Clean stains with a mild detergent.



Everyday Use

Clean the cavity after each use. Fat accumulation or other residue may cause fire.

Moisture can condense in the appliance or on the door glass panels. To decrease the condensation, let the appliance work for 10 minutes before cooking. Do not store the food in the appliance for longer than 20 minutes. Dry the cavity only with a microfibre cloth after each use.



Accessories

Clean all accessories after each use and let them dry. Use only a microfibre cloth with warm water and a mild detergent. Do not clean the accessories in a dishwasher.

Do not clean the non-stick accessories using abrasive cleaner or sharp-edged objects.

11.2 How to remove: Shelf supports

Remove the shelf supports to clean the oven.

Step 1 Turn off the oven and wait until it is cold.

Step 2 Pull the front of the shelf support away from the side wall.

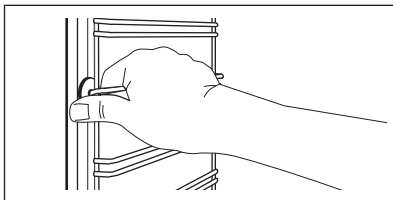

Step 3 Pull the rear end of the shelf support away from the side wall and remove it.

Step 4 Install the shelf supports in the opposite sequence.

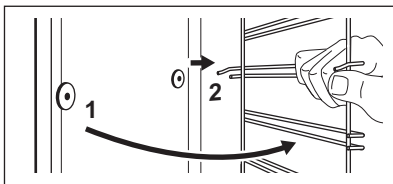

11.3 How to use: Aqua Clean

This cleaning procedure uses humidity to remove remaining fat and food particles from the oven.

Step 1 Pour water into the cavity embossment: 150 ml.

Step 2 Set the function: .

Step 3 Set the temperature to 90 °C.

Step 4 Let the oven work for 30 min.

Step 5 Turn off the oven.

Step 6 Wait until the oven is cold. Dry the cavity with a soft cloth.

11.4 How to remove and install: Door

The oven door has two glass panels. You can remove the oven door and the internal glass panel to clean it. Read the whole "Removing and installing door" instruction before you remove the glass panels.

CAUTION!

Do not use the oven without the glass panels.

Step 1 Open the door fully and hold both hinges.

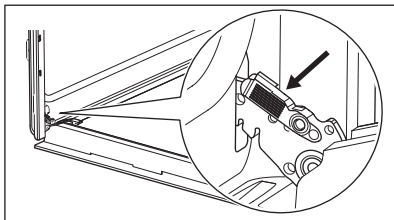

Step 2 Lift and pull the latches until they click.

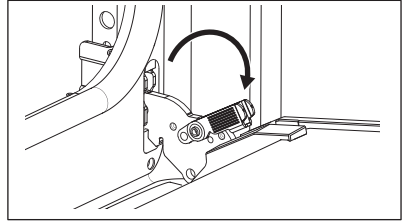

Step 3 Close the oven door halfway to the first opening position. Then lift and pull to remove the door from its seat.

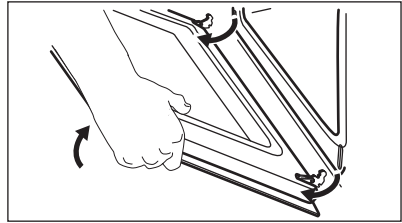

Step 4 Put the door on a soft cloth on a stable surface and release the locking system to remove the internal glass panel.

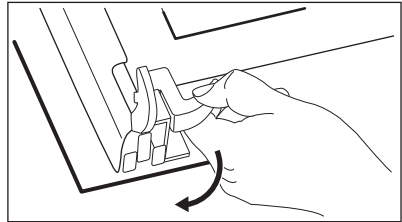

Step 5 Turn the fasteners by 90° and remove them from their seats.

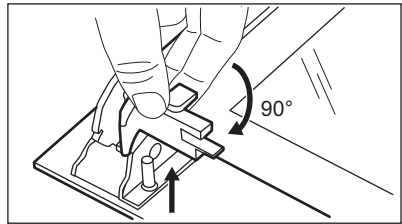

Step 6 First lift carefully and then remove the glass panel.

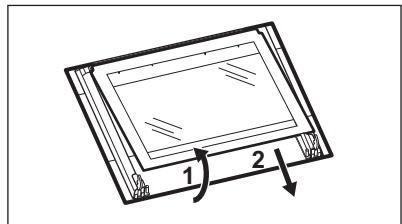

Step 7 Clean the glass panels with water and soap. Dry the glass panels carefully. Do not clean the glass panels in the dishwasher.

Step 8

After cleaning, install the glass panel and the oven door.

If the door is installed correctly, you will hear a click when closing the latches.

When installed correctly the door trim clicks. Make sure that you install the internal glass panel in the seats correctly.

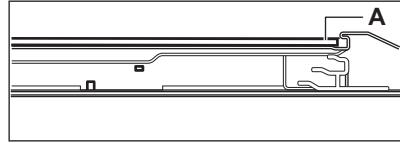

11.5 How to replace: Lamp

⚠ WARNING!

Risk of electric shock.
The lamp can be hot.

Before you replace the lamp:

Step 1	Step 2	Step 3
Turn off the oven. Wait until the oven is cold.	Disconnect the oven from the mains.	Put a cloth on the bottom of the cavity.

Back lamp

Step 1	Turn the glass cover to remove it.
Step 2	Clean the glass cover.
Step 3	Replace the lamp with a suitable 300 °C heat-resistant lamp.
Step 4	Install the glass cover.

12. TROUBLESHOOTING

⚠ WARNING!

Refer to Safety chapters.

12.1 What to do if...

In any cases not included in this table please contact with an Authorised Service Centre.

Problem	Check if...
The oven does not heat up.	The fuse is blown.

Problem	Check if...
The door gasket is damaged.	Do not use the oven. Contact an Authorised Service Centre.
End of Cooking - is not set.	Set: End of Cooking. Refer to "Clock functions".
The lamp does not work.	The lamp is burnt out.

12.2 Service data

If you cannot find a solution to the problem yourself, contact your dealer or an Authorised Service Centre.

The necessary data for the service centre is on the rating plate. The rating plate is on the front frame of the appliance cavity. Do not remove the rating plate from the appliance cavity.

We recommend that you write the data here:

Model (MOD.)

Product number (PNC)

Serial number (S.N.)

13. ENERGY EFFICIENCY

13.1 Energy saving



The appliance has features which help you save energy during everyday cooking.

Make sure that the appliance door is closed when the appliance operates. Do not open the appliance door too often during cooking. Keep the door gasket clean and make sure it is well fixed in its position.

Use metal cookware to improve energy saving.

When possible, do not preheat the appliance before cooking.

Keep breaks between baking as short as possible when you prepare a few dishes at one time.

Cooking with fan

When possible, use the cooking functions with fan to save energy.

Residual heat

When the cooking duration is longer than 30 min, reduce the appliance temperature to minimum 3 - 10 min before the end of cooking. The residual heat inside the appliance will continue to cook.

Use the residual heat to warm up other dishes.

Keep food warm

Choose the lowest possible temperature setting to use residual heat and keep a meal warm.

Moist Fan Baking

Function designed to save energy during cooking.

14. SERVICE AND GUARANTEE IN TAIWAN

The appliance is guaranteed by Electrolux, the major kitchen appliance in Taiwan. Electrolux guarantees to the end user 2 year free warranty services, subject to the terms and conditions listed below:

1. Service and warranty are only applied to Electrolux Inspiration major kitchen appliances sold in Taiwan.
2. Electrolux provides free maintenance service for 2 year commencing from the date of appliance purchase. End users

that register their products online or through mailing back the warranty cards after purchasing.

3. Free maintenance service is valid for the functional components, including PCBs, pumps, motors, heating system...etc.
4. Within the period of warranty, Electrolux shall provide free maintenance service to end users. After the expiration date of warranty, end users will have to afford the fee of repairing and parts. If services

occur, the replaced parts belong to Electrolux.

5. Warranty is invalid in the below cases:
 - The warranty has expired.
 - Damages or malfunctions caused by force majeure, including natural calamities, thunder, accidents...etc.
 - Damages or malfunctions caused by misusing, negligence, improper installation, modification and disassembly, and transportation.
 - Using unauthorized parts.
 - Repaired by other parties.
 - Products used under commercial circumstances, including restaurants, cooking classrooms, baking shops... etc.
 - Not the products imported by Electrolux.
The execution shall obey the latest announced clauses.
6. To ensure your right of warranty, please register the products while purchasing. Ask the retailer to fill up related info for you on the warranty cards and mail them

back to Electrolux or simply register online. Please keep your invoices for data checking.

Service Info

1. Telephone: 0800-888259
 2. E-mail: service.tw@electrolux.com
 3. Service personnel of Electrolux will be wearing uniform and service ID card for distinguishing.
 4. Within the period of warranty, services are free of charge.
 5. When the warranty expired and end users choose not to repair the appliance after inspection, Electrolux will have to charge inspection fee each time.
 6. When the warranty expired and end users choose to repair the appliance after inspection, Electrolux will have to charge the fee of the parts required. Inspection fee will be free of charge.
 7. Prices of parts differ from component to component; Electrolux will have to confirm it after inspection according to the latest quotation.
-

15. ENVIRONMENTAL CONCERNS

Recycle materials with the symbol . Put the packaging in relevant containers to recycle it. Help protect the environment and human health by recycling waste of electrical and electronic appliances. Do not dispose of

appliances marked with the symbol  with the household waste. Return the product to your local recycling facility or contact your municipal office.

electrolux.com

867376934-B-152023



CE