



Electrolux

Instruction Book

UltimateTaste 500

Espresso Machine

E5ECI-31ST

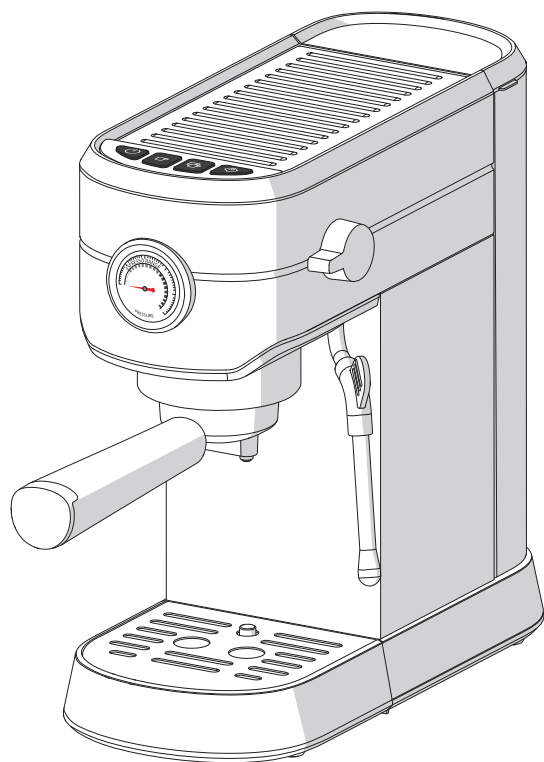

EN INSTRUCTION BOOK

CNT 說明手冊

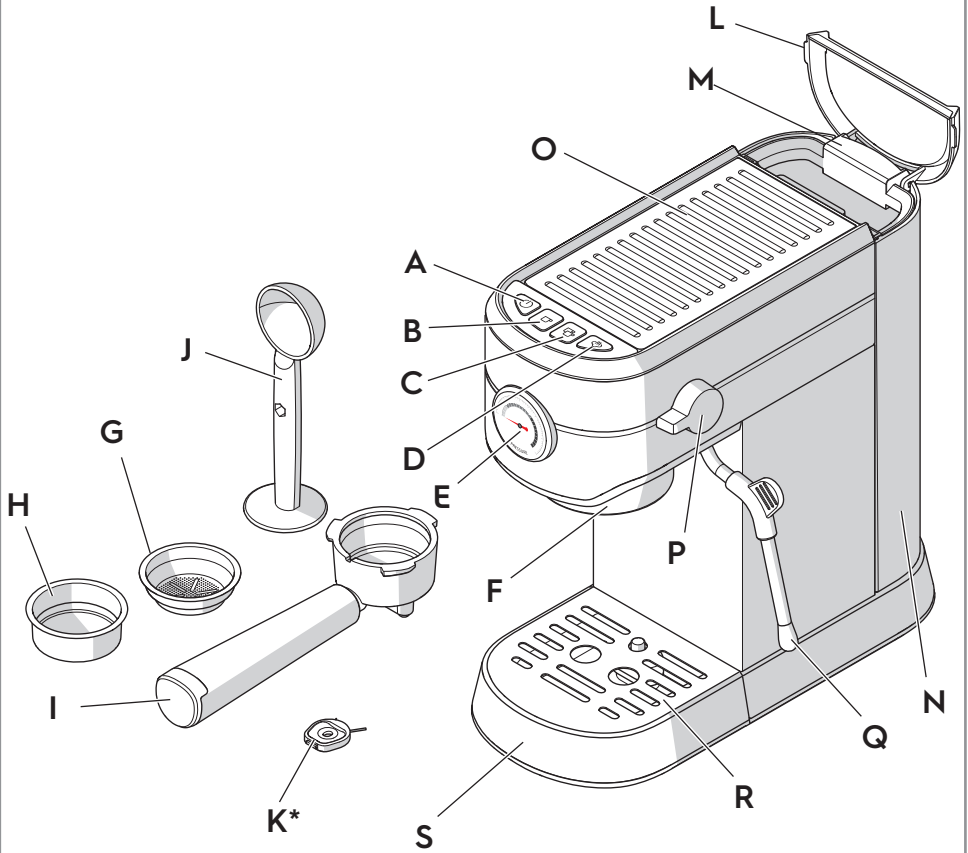

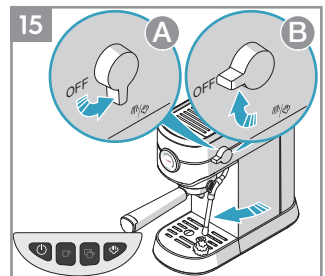
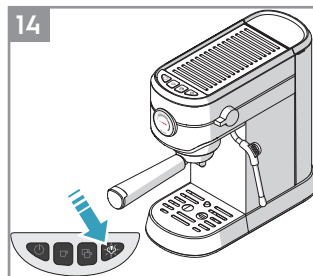
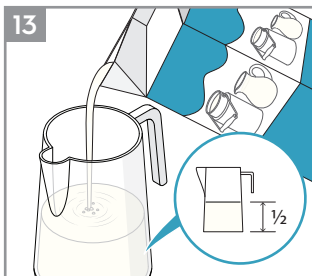
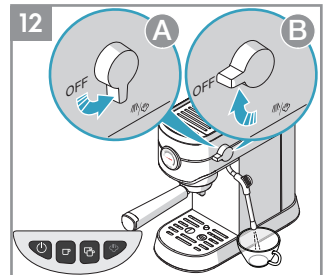
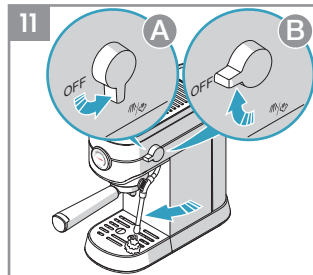
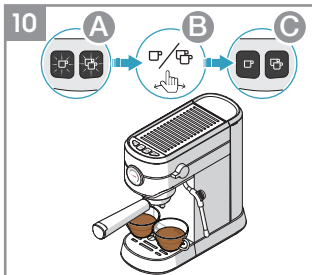
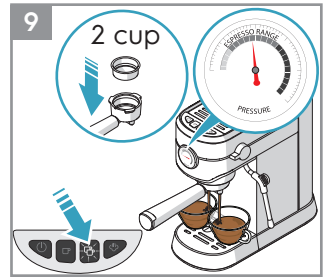
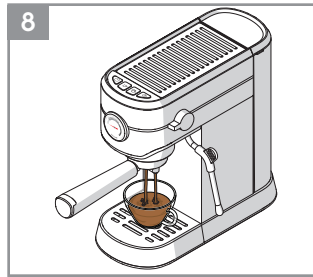
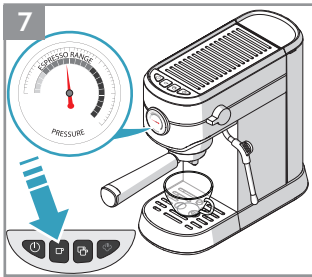
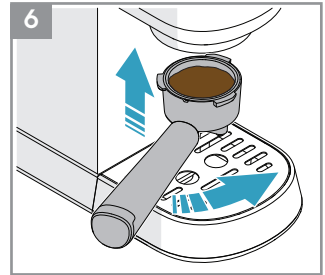
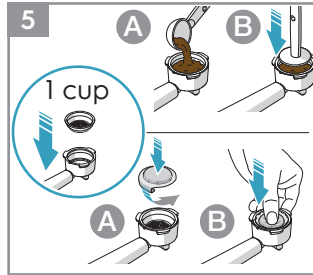
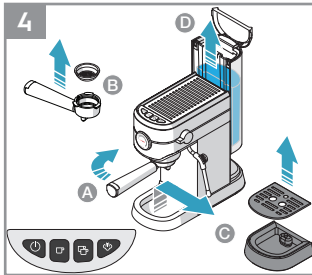
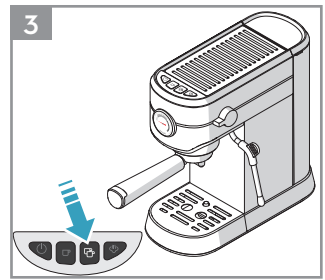
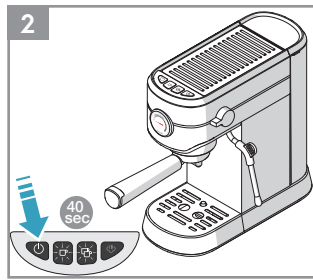
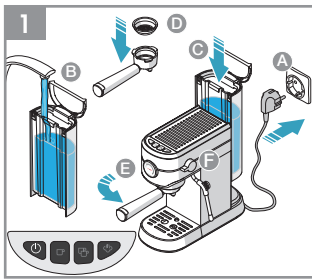

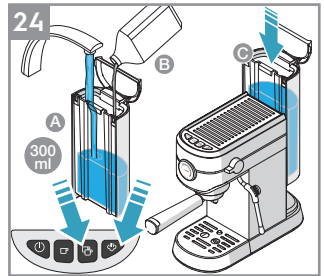
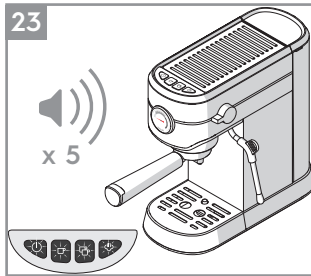
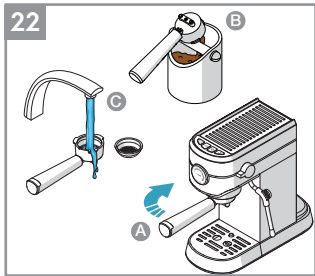
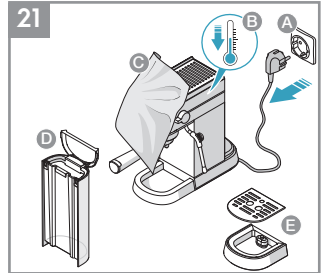
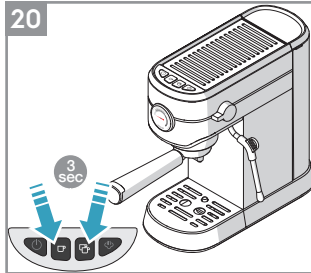
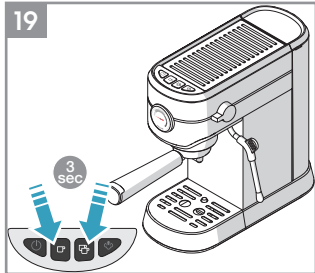
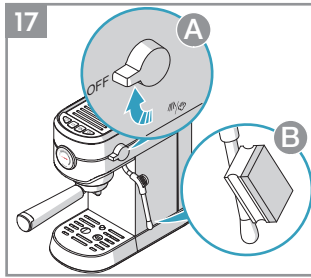
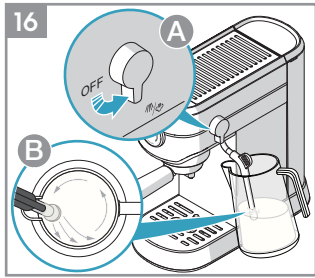

USER MANUAL

Graphics and drawings in this manual are solely for illustration purposes and are subject to variations from actual product

Read all instructions carefully before using the appliance for the first time.

Keep this manual for future reference.

COMPONENTS (picture page 2)

- | | |
|--|---|
| <ul style="list-style-type: none"> A. Power indicator button B. One-cup indicator/button C. Two-cup indicator/button D. Steam indicator/button E. Pressure gauge F. Brewing head G. One-cup/E.S.E pod filter cup H. Two-cup filter cup I. Filter holder | <ul style="list-style-type: none"> J. Tamper/dispenser measure spoon K. Cleaning pin* L. Water tank lid M. Water tank handle N. Water tank O. Cup warmer P. Steam knob Q. Hot water/steam nozzle (milk frother) R. Drip grid S. Drip tray |
|--|---|

* available in certain models only

SAFETY ADVICE

Read the following instructions carefully before using the appliance for the first time.

- This appliance can be used by children aged from 8 years old and above and persons with reduced physical, sensory or mental capabilities or lack of experience and knowledge if they have been given supervision or instruction concerning use of the appliance in a safe way and understand the hazards involved.
- Children shall not play with the appliance.
- Cleaning and user maintenance shall not be made by children unless they are supervised.
- Keep the appliance and its cord out of reach of children less than 8 years old.
- The appliance may only be connected to a power supply with voltage and frequency comply with the specifications on the rating plate.
- Never use the appliance if
 - the supply cord is damaged,
 - the housing is damaged.
- The appliance must only be connected to an earthed socket. If needed, an extension cable suitable for 10 A can be used.
- If the appliance or the supply cord is damaged, it must be replaced by the manufacturer, its service agent or similarly qualified person to avoid hazard.
- Always place the appliance on a flat, level surface.
- The appliance must be switched off and unplugged each time after use, before cleaning and maintenance.
- The appliance and accessories become hot during operation. Use only designated handles and knobs. Allow to cool down before cleaning or storage.
- The mains cable must not come into contact with any hot parts of the appliance.
- Do not remove the water tank during the brewing process.
- Do not remove the filter holder during the brewing process or when there's steam / hot water flowing from the filter holder as the appliance is pressurized. **DANGER! There is risk of scalding.**
- Release pressure through hot water/steam nozzle (follow instruction step 11) before removing filter holder. **Warning: Avoid steam burn.**
- When the steam function is used, there can be some hot water dripping from the brewing head. **DANGER! The water is hot, there is a risk for scalding.**
- When opening the steam knob, there is a shot of hot water coming out. Be careful and open the steam valve slowly. **DANGER! The water is hot, there is a risk for scalding.**
- Do not immerse the appliance in water or any other liquid.
- Do not exceed the maximum filling volume as indicated on the appliances.
- Fill the water tank only with cold water, never with milk or other liquids.
- Always use fresh water to brew espresso for the best taste.





- Do not use the appliance if the water tank has not been filled.
- Do not use the appliance without the drip tray or drip grid, unless a higher cup/mug is in use.
- Do not use or place the appliance on a hot surface or near source of heat.
- **Warning:** Avoid spillage on the connector.
- This appliance is intended for domestic use only. The manufacturer cannot accept any liability for possible damage caused by improper or incorrect use.
- This appliance is not intended to be operated by means of an external timer or separate remote-control system.

This appliance is for used in household and similar applications such as:











- staff kitchen areas in shops, offices and other working environments;
- farmhouses;
- used by clients in hotels, motels and other residential type environments;
- bed and breakfast type environments.

GETTING STARTED (picture page 3 and 4)

Start the machine for the first time

1. Place the machine on a flat surface. Plug in the machine to turn on its stand-by mode, with  button turns half on. Fill the tank with cold pure water. Put filter cup into filter handle, and then secure it onto brewing head anti-clockwise from "INSERT" to "LOCK" position without coffee. Make sure the knob is at the horizontal position ("OFF" position).
2. Start the machine with  button, with light turns fully on and  and  buttons start blinking.
3. When buttons stop blinking, pre-heating is done. Press  button to start brewing process. **NOTE: There may be noise when pumping the water for the first time. It is normal. The machine is releasing the air from inside. The noise will stop after about 20 seconds.**
4. When brewing is finished, remove the filter handle clockwise, clean the filter and the drip tray. Now the machine is ready to use. **NOTE: The machine will turn off automatically after 20 mins of no operation.**











Make espresso coffee

5. **Put one-cup filter cup into filter handle.** Add one spoon of ground coffee, press it tight with tamper; or add an E.S.E pod and put it into filter cup. **E.S.E (Easy Serving Espresso) Pods can be used to simplify the espresso preparation. Each pre-packed pod contains 7 grams of coffee, already measured, pressed and sealed between 2 fine layers of filter paper.**
6. Attach the filter holder onto the brewing head in anti-clockwise direction from "INSERT" to "LOCK" position.
7. Put a warm cup on the drip tray. When pre-heating is done,  and  and  buttons fully light up, press  button to start brewing process.
8. The machine will stop operation when the brewing is done.
9. To brew 2 cups of espresso at the same time, press  button.
10. **NOTE:** If both  and  buttons start blinking quickly, you may simply press  or  button to cancel brewing, or (step 11)
11. (step 10) you may restart brewing after cooling down the boiler. Turning the knob to  position to release hot water from steam nozzle. The pump stops working automatically when it has cooled down. Turn the knob off and resume brewing.









Make hot water

12. When pre-heating is done,  and  and  buttons fully light up, turn the knob to  position. Hot water will flow out from the steam nozzle. Turn the knob off when you get the needed amount.

Froth milk and make cappuccino/latte

13. Fill a jug with 100ml (for cappuccino) or 200ml (for latte) milk. **Note: make sure jug diameter is no less than 70±5mm, and jug capacity can hold twice the milk volume after frothed.**
14. When pre-heating is done,  and  and  buttons fully light up. Press  button, it starts blinking. **NOTE: Use full milk at refrigerator temperature (NOT HOT!)**
15. When the  button stops blinking, steam / milk frothing function is ready. Before frothing milk, push steam nozzle in the direction of drip tray, turn the knob to  position to release steam until there's no water coming out, turn off steam function by turning the knob back to horizontal "OFF" position.
16. Immerse steam nozzle in milk about 2cm under the milk surface, turn on the knob. Make sure the steam nozzle is placed in a position that makes the milk turning in one direction inside the jug from top to bottom.
17. When the desired level of foam is reached, turn off the knob. **Note: Clean steam nozzle with wet sponge immediately after steam stops generating. Be careful not to get hurt! The pump automatically stops working after frothing milk for 3 minutes.**
18. Pour the frothed milk into the espresso prepared, now the cappuccino/latte is ready. Sweeten to taste and if desired, sprinkle the froth with a little cocoa powder. **NOTE: After frothing milk, you may immediately make espresso again by pressing  or  button. If both  and  buttons start blinking quickly, cool down the boiler and resume brewing (see step 11)**











DIY / VOLUME

19. When pre-heating is done,  and  and  buttons fully light up, press and hold  /  button for 3 seconds to start resetting mode. Press  /  button to start brewing and press again to stop when the desired volume is reached. Now the volume is saved for next operations.
20. Restore factory default setting simply by simultaneously pressing  and  buttons for 3 seconds again.

CLEANING AND CARE

21. Turn the machine off and unplug the power cord. Let the machine cool down completely before cleaning. Wipe all outer surfaces with a damp cloth. Clean water tank, drip tray and drip grid regularly. Never use caustic or abrasive cleaners, and never immerse the machine in liquid! **NOTE: only the filter cups are dishwasher safe.**
22. Detach the filter handle by turning it clockwise. Scrap coffee residue or used E.S.E pod. Extract the filter cup from the filter holder, rinse them with clean water and dry thoroughly.

DECALCIFYING

23. Descaling is recommended when all indicators blink 5 times with 5 beeps at the moment machine is turned on. **Descaling warning will repeat 2 more times when you turn on the appliance if you do not perform descaling or do not cancel by simultaneously pressing  and  and  for 3 seconds.**
24. Fill the water tank to 300ml level with water and then add the descaling agent (or fill in water and vinegar 1:1). **Use only an environmentally friendly descaling agent and always follow the manufacturer's instructions.** When pre-heating is done,  and  and  buttons fully light up, simultaneously press  and  for 3 seconds to start descaling process, during which  and  buttons are blinking slowly one after another. When descaling completes, the machine will return to stand-by mode. Perform step 1-4 twice before using the machine.

Enjoy your new Electrolux product!

TROUBLESHOOTING

PROBLEM	POSSIBLE CAUSE	SOLUTION
Water leaks from the bottom of coffee maker.	There is too much water in the drip tray.	Please clean the drip tray.
	The coffee maker malfunctions.	Please contact with the authorized service facility for repairing.
Water leaks outside of filter cup.	There is some coffee powder on filter edge when attached to the brewing head.	Clean the coffee powder on the filter edge.
Acid (vinegar) taste exists in espresso coffee.	Didn't perform descaling correctly	Clean up machine according to step 1-4 for "start the machine for the first time"
	The coffee powder is stored in a hot, wet place for a long time. The coffee powder turns bad.	Please use fresh coffee powder, or store unused coffee powder in a cool, dry place. After opening a package of coffee powder, reseal it tightly and store it in a refrigerator to maintain its freshness.
The coffee maker cannot work anymore or does not respond at all.	The power outlet is not plugged well.	Plug the power cord into an earthed socket correctly. If the appliance still does not work, please contact with the authorized service facility for repairing.
The steam / milk frothing does not work properly.	The white indicator is not illuminated.	Only after the white indicator is illuminated, the steam station can be used to perform milk frothing.
	The container is too big or the shape does not fit	Use high and narrow cup or professional milk frothing jug.
	You have used skimmed milk	Use whole milk or half-skimmed milk.
Steam indicator blinking quickly	Continuously steaming for 3 minutes and the steam knob is not reset.	Reset steam knob to "OFF" position.
One-cup indicator and two-cup indicator blinking quickly	Dispense 40ml of hot water and the steam knob is not reset	Reset steam knob to "OFF" position.
	The steam knob is not reset after cooling down.	
	Boiler temperature is too high.	Cool it down by perform STEP 11
One-cup indicator, two-cup indicator and steam indicator blinking quickly	The steam knob is not reset, but the machine is turned on	Reset steam knob to "OFF" position
ALL indicators blinking at the same time for 5 times	Need descaling	Perform decalcifying
Filter handle is too tight to operate	Fill too much coffee powder in the filter cup.	Fill filter cup with less coffee powder
Coffee flows drip by drip	Too much coffee powder	Fill filter cup with less coffee powder
	Coffee powder is too fine, and tamped too tight	Use coarser coffee powder or tamp coffee powder with less force
	Filter cup is blocked	Clean the filter cup with cleaning pin

DISPOSAL

Recycle the materials with the symbol . The packaging materials can be recycled. Please sort individual components by type and dispose them in applicable containers according to local disposal instructions. Recycling of packaging materials reduces the use of raw materials and amount of waste in landfill sites. Help protect the environment and human health by recycling your packaging.

Do not dispose appliances marked with the symbol  with the household waste. Return the product to your local recycling facility or contact your municipal office.

Electrolux reserves the right to change products, information and specifications without notice.

用戶手冊

本手冊中的圖形和圖片僅供說明之用，可能與實際產品有所不同。

首次使用本產品之前，請詳讀所有說明。

請妥善保管本手冊以便隨時參閱。

組件 (圖片第2頁)

- | | |
|--------------------|----------------------|
| A. 電源指示燈/按鈕 | J. 壓粉器/測量勺 |
| B. 單杯指示燈/按鈕 | K. 清潔針* |
| C. 雙杯指示燈/按鈕 | L. 水箱蓋 |
| D. 蒸汽指示燈/按鈕 | M. 水箱把手 |
| E. 壓力計 | N. 水箱 |
| F. 沖煮頭 | O. 溫杯器 |
| G. 單杯/E.S.E咖啡易理包濾網 | P. 蒸汽旋鈕 |
| H. 雙杯濾網 | Q. 熱水/蒸汽噴嘴 (牛奶起泡器) |
| I. 濾網把手 | R. 滴水網 |
| | S. 滴水盤 |

* 僅某些型號適用

安全使用建議

首次使用本產品之前，請詳讀以下說明。





- 本產品可供8歲及以上兒童，以及身體、感官或精神力有障礙者或缺乏經驗和知識的人士使用，但前提是他們已由負責其安全的人士對設備的使用進行監督或指導，並已瞭解其中的危險。
- 兒童不應把本產品當作玩具玩耍。
- 除非有專人監督，否則不得由兒童進行清潔和維護。
- 請將本產品及其電源線放在8歲以下兒童接觸不到的地方。
- 本設備只能連接到電壓和頻率符合銘牌規定的電源。
- 如果出現以下情況，切勿使用或拿起該設備：
 - 電源線損壞
 - 外殼損壞
- 該設備只能連接到接地插座，如果需要，可以選配一個10A的延長線。
- 如果本產品或其電源線遭受損壞，必須由製造商或授權服務代理商或具備類似資格的人員更換，以避免造成危險。
- 始終將本產品放置在平坦穩固的平面上。
- 在使用後、清潔和維護前，必須關閉本產品並拔掉電源插頭。
- 本產品及其配件在運行過程中會變熱，此時只能使用指定手柄和旋鈕。請等待本產品冷卻後再清洗或存放。
- 不得將電源線接觸本產品的任何發熱部件。
- 請勿在沖煮過程中拆卸水箱。
- 沖煮過程中或本產品加壓過程中 (蒸汽/熱水從濾網把手中逸出時)，請勿拆卸濾網把手。危險！存在燙傷風險！
- 卸下濾網把手前，透過熱水/蒸汽噴嘴釋放壓力 (按照說明步驟 11)。
- 警告：避免蒸汽灼傷。
- 使用蒸汽功能時，可能會有熱水從沖煮頭處滴落。危險！水溫很高，存在燙傷風險！
- 打開蒸汽旋鈕時可能會噴出一股熱水。務必小心地慢慢打開蒸汽閥。危險！水溫很高，存在燙傷風險！
- 請勿將本產品浸泡在水中或任何其他液體中。
- 請嚴格遵守本產品機身上標明的最大裝載量。
- 水箱中只能裝入冷水，切勿灌入牛奶或其他液體。
- 為保證最佳口感，始終用淡水沖煮意式濃縮咖啡。
- 水箱在未裝水的情況下，請勿運行本產品。
- 沒有滴水盤或滴水網時，請勿運行本產品，除非您使用較高的杯子/馬克杯。
- 請勿在發熱表面或熱源附近使用或存放本產品。
- 警告：避免液體濺到接頭。
- 本產品僅供家庭環境使用。對於因使用不當或不正確使用而可能造成的任何損壞，製造商不承擔任何責任。
- 本產品不能透過外部計時器或單獨的遠端控制系統操作。

本產品旨在用於家庭和類似環境，例如











- 商店、辦公室和其他工作環境中的員工廚房區域；
- 農舍；
- 酒店、旅館和其他住宅類型環境中的客戶；
- 住宿加早餐型環境。

開始使用 (圖片第3和4頁)





首次使用本產品

1. 將機器放在平穩檯面。插上插頭以開啟待機模式，同時將  按鈕打開至一半位置。在水箱中裝入冷的純淨水。將濾網內放入濾網把手，並從“INSERT”位置逆時針旋轉到“LOCK”位置，以固定到沖煮頭上，不要放入咖啡。確保旋鈕處於水平位置 (“OFF”位置)。
2. 按下  啟動機器，指示燈完全亮起， 和  按鈕開始閃爍。
3. 按鈕停止閃爍即代表預熱完成。按下  按鈕開始沖煮。注意：初次抽水時可能有噪音，這是正常現象。機器正在內部向外排出空氣，大約20秒後噪音會停止。
4. 沖煮結束後，順時針卸下濾網把手，清理濾網和滴水盤。然後就可以開始使用機器了。注意：如果在20分鐘內沒有進行任何操作，機器會自動關閉。







製作特濃咖啡

5. 將單杯濾網放入濾網把手。放入一勺咖啡粉，用壓粉器壓緊；或將E.S.E咖啡易理包放入濾網內。E.S.E (Easy Serving Espresso) 咖啡易理包可以用來簡化濃縮咖啡的製備。每個預包裝的咖啡易理包內含7克咖啡，已經測量、壓制並密封在兩層極細密的濾紙之間。
6. 將濾網把手從“INSERT”位置逆時針旋轉到“LOCK”位置，以固定到沖煮頭上。
7. 將溫熱的杯子放在滴水盤上。在“預熱完成”模式中，,  和  按鈕全部穩定地完全亮起，按下  開始沖煮咖啡。
8. 稍等片刻，頂級香醇的咖啡將流入杯子。機器停止運行時，您的咖啡就準備好了。
9. 現在試試雙杯模式。按下  按鈕。同時沖煮2杯特濃咖啡。
10. 注意：如果  和  兩個按鈕同時快速閃爍，您可以按下  或  按鈕取消沖煮，或 (步驟11)
11. (步驟10) 機器冷卻後，您可以重新開始沖煮。將旋鈕轉到 ，蒸汽噴嘴將會噴出熱水。冷卻完畢後，水泵會自動停止運行。關掉旋鈕，繼續沖煮。





製作熱水

12. 在“預熱完成”模式中，,  和  按鈕全部穩定地完全亮起，將旋鈕轉到 ，蒸汽噴嘴將會噴出熱水。獲得足夠熱水後，關掉旋鈕。









打奶泡並製作卡布奇諾/拿鐵咖啡

13. 將100毫升 (製作卡布奇諾) 或200毫升 (製作拿鐵) 牛奶注入壺中。注意：選擇直徑不小於70±5公釐的壺，並且其容量應至少為注入牛奶的兩倍 (起泡完成後，牛奶的體積翻倍)
14. 在“預熱完成”模式中，,  和  按鈕全部穩定地完全亮起，按下 ，指示燈開始閃爍。注意：使用冷藏室溫度下的全脂牛奶 (不要使用熱牛奶！)。
15.  按鈕停止閃爍時，蒸汽/打奶泡功能準備就緒。打奶泡前，將蒸汽噴嘴推向滴水盤方向，將旋鈕轉到  釋放蒸汽，直到沒有水流出時再將旋鈕轉回水平“OFF”位置，關閉蒸汽功能。
16. 將蒸汽噴嘴浸入牛奶，置於牛奶表面下約2釐米深，打開旋鈕。確保蒸汽噴嘴放置在一個能使牛奶在壺內從上到下朝一個方向轉動的位置。
17. 獲得您想要的奶泡後，關閉旋鈕。注意：停止產生蒸汽後請立即用濕海綿清潔蒸汽噴嘴，但要注意不要受

傷！打奶泡功能運行3分鐘後，水泵自動停止運行。

18. 將起泡的牛奶倒入準備好的意式濃縮咖啡中，卡布奇諾/拿鐵咖啡就製作好了。您可根據個人喜好調味，如有需要也可以在奶泡上撒一點可可粉。注意：在蒸汽功能結束後，您可以立即按下  或  按鈕再次製作意式濃縮咖啡。如果  和  按鈕都開始快速閃爍，請等待機器冷卻後再繼續沖煮（見步驟11）。











自訂 / 容量

19. 在“預熱完成”模式中，、 和  按鈕全部穩定地完全亮起，長按  或  三秒，啟動重訂模式。
按下  或  按鈕開始沖煮，獲得所需容量後再次按下按鈕停止。現在，機器已保存該容量資料，並自此在下次運行時默認使用。
20. 只需再次同時長按  和  3秒，即可恢復出廠默認設置。

清潔和保養

21. 關閉機器並拔掉電源線。等待機器完全冷卻後再進行清潔。用濕布擦拭所有外表面。定期清洗水箱、滴水盤和滴水網。切勿使用腐蝕性或研磨性清潔劑，也不要將機器浸泡在液體中！注意：僅濾網可用洗碗機清洗。
22. 順時針旋轉咖啡手柄以將其拆下。刮掉咖啡殘渣或用過的E.S.E咖啡易理包。從濾網把手上拿出濾網，用乾淨的水沖洗並徹底晾乾。

除垢

23. 如果開機時，所有指示燈將閃爍5次並伴有5聲蜂鳴，代表您該除垢了。如果您不除垢，也不同時長按 、 和  3秒取消，那麼在您開機時將重複2次除垢警告。注意：如果不定期除垢，則因水垢導致的咖啡機問題維修不在保修範圍內。
24. 在水箱中加水，直到300毫升刻度，然後加入除垢劑（或加水和醋，比例為1:1）。僅可使用環保型除垢劑，並應始終遵循製造商的說明。在“預熱完成”模式中，、 和  按鈕全部穩定地完全亮起，同時長按  和  3秒，開始除垢。在此期間， 和  按鈕將會依次緩慢閃爍。除垢完成後，機器將回到待機模式。再次使用機器前，請執行步驟1-4兩次。

盡情享受您的新伊萊克斯產品吧！

故障排除

故障	可能原因	解決辦法
咖啡機底部漏水	滴水盤裡的水過多。	請清潔滴水盤。
	咖啡機發生故障。	請與伊萊克斯售後服務部門聯繫維修。
濾網漏水	鎖定在沖煮頭上時，濾網邊緣有一些咖啡粉。	清除濾網邊緣的咖啡粉。
意式濃縮咖啡中有酸(醋)味	沒有正確除垢	按照“首次啟動機器”的步驟1-4清理機器
	咖啡粉長期存放在高溫、潮濕的地方。咖啡粉變質。	請使用新鮮的咖啡粉，或將未使用的咖啡粉存放在陰涼、乾燥的地方。咖啡粉包裝打開過後，請重新將其密封並存放在冰箱中以保持其新鮮度。
咖啡機無法再運行，或根本沒有反應	電源插座沒有插好。	將電源正確插入接地的插座。如果機器仍然無法運行，請與伊萊克斯售後服務部門聯繫維修。
蒸汽/打奶泡功能不能正常運行	白色指示燈沒有亮起。	僅在白色指示燈亮起後，才能使用蒸汽噴嘴打奶泡。
	容器太大或者形狀不合適。	請使用高窄杯或專用的牛奶起泡壺。
	您使用了脫脂牛奶	使用全脂牛奶或半脫脂牛奶。
蒸汽指示器快速閃爍	連續使用蒸汽噴嘴超過3分鐘，蒸汽旋鈕並未復位。	將蒸汽旋鈕復位到“OFF”位置。
單杯指示燈和雙杯指示燈快速閃爍	放了40毫升熱水後，蒸汽旋鈕並未復位。	將蒸汽旋鈕復位到“OFF”位置。
	蒸汽旋鈕在機器冷卻後沒有復位。	
	機器溫度太高。	執行步驟11，讓機器冷卻
單杯指示燈、雙杯指示燈和蒸汽指示燈快速閃爍	蒸汽旋鈕沒有復位，但機器開機了	將蒸汽旋鈕復位到“OFF”位置。
所有指示燈同時閃爍5次	需要除垢	除垢
咖啡手柄太緊，無法操作	濾網裡裝了太多咖啡粉	在濾網中少加一些咖啡粉
咖啡逐滴流出	咖啡粉太多	在濾網中少加一些咖啡粉
	咖啡粉太細，壓得太緊	研磨較粗顆粒的咖啡粉或用較小的力氣壓實咖啡粉
	濾網堵塞	用清潔針清潔濾網

廢棄處置

帶有  標誌的材料需要回收。包裝材料可以回收利用。請按類型對各元件進行分類，並根據當地的棄置處理政策說明將其放在指定的收集站。包裝材料的回收利用減少了原材料的使用和垃圾填埋場的垃圾量。回收您的包裝，保護環境和人類健康。



請勿將帶有  標誌的電器與家庭垃圾一起處理。請將產品送回當地的回收機構或聯繫您當地的政府機關。

伊萊克斯保留更改產品、資訊和規格的權利，恕不另行通知。

有鑒於世界各國對綠色環保意識的重視，伊萊克斯依循RoHS「危害性限制物質指令」誠實標示產品化學物質含量，關於本產品的RoHS聲明書，請上伊萊克斯官網 ---> 「支援服務」---> 「RoHS聲明書」，依產品類別及型號檢索。

<http://www.electrolux.com.tw/Support/Customer-Care/>

中国

伊莱克斯 (中国) 电器有限公司
上海市虹口区公平路168号
北外滩来福士广场办公楼30层
售后服务: +86 9510 5801
网站: www.electrolux.com.cn

台灣

新加坡商伊莱克斯股份有限公司 台灣分公司
105408 台北市松山區敦化南路一段3號4樓
免付費客服專線: 0800-888-259
電郵: service@electrolux.com.tw
網站: www.electrolux.com.tw

KOREA

Electrolux Korea limited
9F, Pine Avenue B,
100 Euljiro, Jung-gu, Seoul, Korea 04551
Korea
Tel : +82 2 6020-2200
Fax: +82 2 6020-2271-3
Customer Care Services : +82 1566-1238
Email : homecare.krh@electrolux.com
Website: www.electrolux.co.kr

INDONESIA

PT. Electrolux Indonesia
Electrolux Building 2nd Floor
Jl. Abdul Muis No 34,
Jakarta Pusat 10160
Indonesia
Tel: +62 21 5081 7303
Fax: +62 21 5081 8069
SMS/WA : 0811-8339-777
Customer Care Services: 0804111 9999
Email: customer-care@electrolux.co.id
Website: www.electrolux.co.id

PHILIPPINES

Electrolux Philippines, Inc.
12th Floor, Cyber Sigma Building
Lawton Avenue, Mckinley West, Fort Bonifacio
Taguig City, Philippines 1634
Domestic Toll Free: 1-800-10-845-CARE (2273)
Customer Care Services: (02) 845-CARE (2273) /
(02)-8845-4663
Email: wecare@electrolux.com
Website: www.electrolux.com.ph

THAILAND

Electrolux Thailand Co Ltd
Electrolux Building
14th Floor 1910 New Petchburi Road
Bangkapi, Huay Kwang
Bangkok 10310
Thailand
Tel: +66 2 725 9100
Fax: +66 2 725 9299
Customer Care Services: +66 2 725 9000
Email: customer-carethai@electrolux.com
Website: www.electrolux.co.th

VIETNAM

Electrolux Vietnam Ltd
Floor 10, Sofic Tower, 10 Mai Chi Tho,
Thu Thiem Ward,
Thu Duc City
Ho Chi Minh City
Vietnam
Tel: +84 8 3910 5465
Fax: +84 8 3910 5470
Customer Care Services: 1800-58-8899
Email: vn-care@electrolux.com
Website: www.electrolux.vn

MALAYSIA

Electrolux Home Appliances Sdn Bhd
Lot C6, No. 28, Jalan 15/22,
Taman Perindustrian Tiong Nam,
40200 Shah Alam, Selangor
Malaysia
Customer Care Services Tel: +60 3 5525 0800
Customer Care Services Fax: +60 3 5524 2521
Email: malaysia.customer-care@electrolux.com
Website: www.electrolux.com.my

SINGAPORE

Electrolux SEA Pte Ltd
351 Braddell Road #01-04
Singapore 579713
Customer Care Services: +65 6727 3699
Email: customer-care.sin@electrolux.com
Website: www.electrolux.com.sg

UAE

ELECTROLUX APPLIANCES
MIDDLE EAST DMCC,
P.O.BOX 336148, Unit No. 4001,
MAZAYA BUSINESS AVENUE BBI,
JUMEIRAH LAKE TOWERS, Dubai,
United Arab Emirates

