

Instruction Book

說明手冊



FLOW **A3**

FA31-202GY



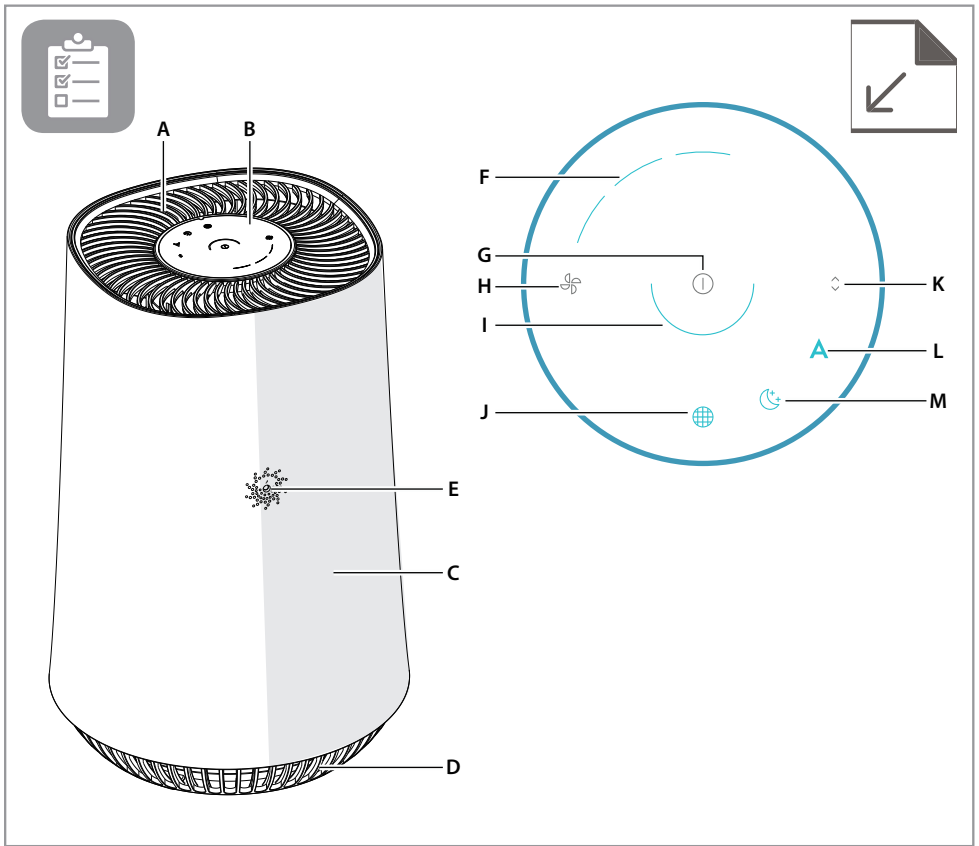

EN DESCRIPTION OF YOUR AIR PURIFIER FLOW A3

Appliance:

- A. Air outlet
- B. UI panel
- C. Main body
- D. Base
- E. Sensor window & Adapter jack

Control panel:

- F. Fan speed indicator
- G. Power on/off
- H. Fan speed control
- I. Air quality indicator
- J. Filter change indicator
- K. Toggle mode & Filter reset
- L. Auto mode indicator
- M. Sleep mode indicator

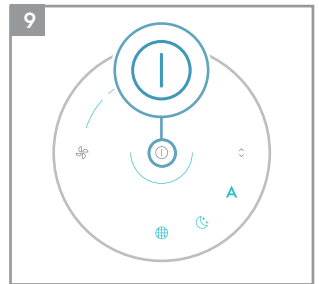
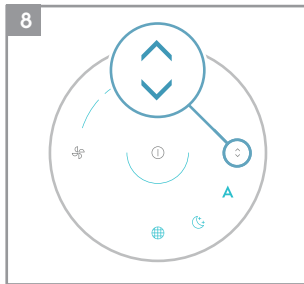
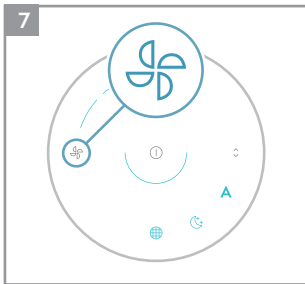
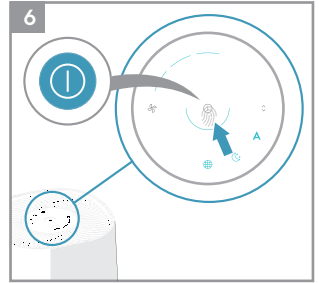
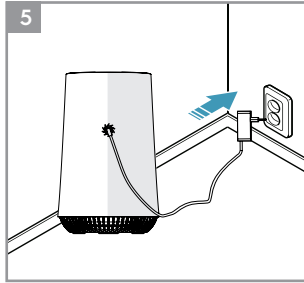
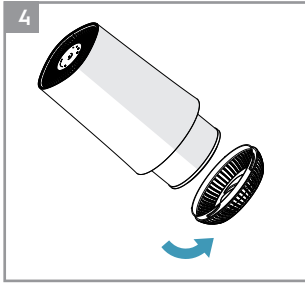
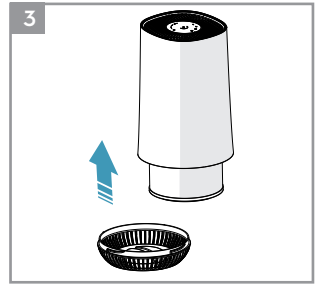
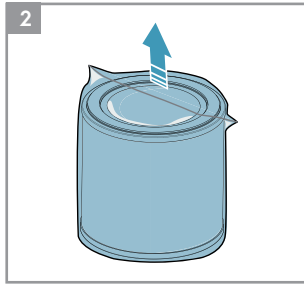
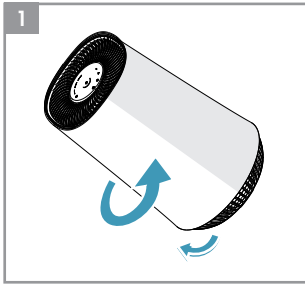

SAFETY INFORMATION

This USER MANUAL provides specific operating instructions for your model. Use the unit only as instructed in this USER MANUAL. These instructions are not meant to cover every possible condition and situation that may occur. Common sense and caution must be practiced when installing, operating, and maintaining any appliance.

WARNING! Avoid fire hazard or electric shock. Do not use an extension cord or an adaptor plug. Do not remove any prong from the power cord. This appliance can be used in 50Hz or 60Hz power supply without any change.

Do not under any circumstances, cut, remove or bypass the grounding prong.

Do not store or use gasoline or other flammable vapors and liquids in the vicinity of this or any other appliance. Read product labels for flammability and other warnings.

Do not let water or any other liquid or flammable detergent enter the appliance to avoid electric shock and/or a fire hazard.

Do not touch the fan blade when removing the filter.

Children and Vulnerable People Safety

WARNING! Risk of suffocation, injury or permanent disability.

This appliance can be used by children aged from 8 years and above and persons with reduced physical, sensory or mental capabilities or lack of experience and knowledge if they have been given supervision or instruction concerning use of the appliance in a safe way and understand the hazards involved.

Children shall not play with the appliance.

Cleaning and user maintenance shall not be made by children without supervision.

Children under 3 years of age should be kept away from the appliance unless continuously supervised.

Keep all packaging away from children.

If the appliance has a child safety device, we recommend you activate it.

Electrical Information

WARNING! Avoid fire hazard or electric shock.

If you are not sure the outlet is adequately grounded or protected by a time delay fuse or circuit breaker, have a qualified electrician install the proper outlet according to the National Electrical Code and applicable local codes and ordinances.

Do not use an extension cord or an adapter plug.

Never unplug the unit by pulling on the power cord. Always grip the plug firmly and pull straight out from the receptacle.

Do not pinch, bend, or knot the power cord.

Do not cut or damage the power cord. If the power cord is damaged, it should only be replaced by an authorized Electrolux servicer. This unit contains no user-serviceable parts. Always call an authorized Electrolux servicer for repairs.

If the supply cord is damaged, it must be replaced by the manufacturer, its service agent or similarly qualified persons in order to avoid a hazard.

Be sure to unplug the unit before cleaning to prevent shock or fire hazards.

Safety Precautions

CAUTION! Avoid Serious Injury or Death.

Do not insert or place fingers or objects into the air discharge area or front grille of the unit.

Do not start or stop the unit by unplugging the power cord or turning off the power at the electrical box.

In the event of a malfunction (sparks, burning smell, etc.), immediately stop the operation, disconnect the power cord, and call an authorized Electrolux servicer. Do not operate the unit with wet hands.

Do not pull on the power cord.

CAUTION! Avoid Injury or damage to the unit or other property.

Do not direct airflow at fireplaces or other heat related sources as this could cause flare ups.

Do not climb on or place objects on the unit.

Do not hang objects off the unit.

Do not place containers with liquids on the unit.

Turn off the unit at the power source when it will not be used for an extended period of time.

Operate the unit with air filter in place.

Do not block or cover the intake grille, discharge area and outlet ports.

Ensure that any electrical/electronic equipment is 30 cm away from the unit.

DISPOSAL



This symbol on the product indicates that this product contains a battery which shall not be disposed with normal household waste..



This symbol on the product or on its packaging indicates that the product may not be treated as household waste.

To recycle your product, please take it to an official collection point or to an Electrolux service center that can remove and recycle the battery and electric parts in a safe and professional way. Follow your country's rules for the separate collection of electrical products and rechargeable batteries.

ENGLISH

Thank you for choosing the Electrolux air purifier FLOW A3.

Always use original accessories and spare parts to get the best results. This product is designed with the environment in mind. All plastic parts are marked for recycling purposes.

BEFORE STARTING

- Read this manual carefully.
- Check that all parts described are included.
- Pay special attention to the safety precautions!

SET UP

The filters have to be installed before use.

Caution: Switch off the device before installing filters.

1 Open the base of the filter

Open the product by rotating the base in anticlockwise direction with the handle provided at the bottom till it comes loose (ref. picture 1).

2 Take out the filter and remove the filter bag

Carefully remove the filter including plastic packaging from the unit and break open the plastic bag and discard appropriately (ref. picture 2).

3 Install the filter

Carefully insert the filter back into the product without the plastic packaging (either end of the filter works). Take care that the filter is placed in the center of the cavity (ref. picture 3).

4 Close the base

Close the product by rotating the base in clockwise direction with the handle provided at the bottom till it is securely in place. (ref. picture 4).

OPERATION

Caution: Please ensure the filters are correctly inserted in the filter compartment, the equipment is installed on a level surface and the power plug is firmly connected.

5 Connect the power plug.

6 Power on

Power on the product by gently touching the ON/OFF icon on the center of the product (ref. picture 6).

7 Fan speed control

Change the fan speed by gently touching fan icon on the product. If the product is in AUTO mode, it will switch to manual mode on touching the fan icon. (ref. picture 7).

8 Auto mode and sleep mode

Change between AUTO and Sleep mode by gently touching icon labeled " ◇ ".

In AUTO mode the unit will adjust operation according to latest air quality (PM2.5 level). In SLEEP mode unit will operate at the low noise level and all indicators except for SLEEP icon will go off.

9 Power off

Power down the product by gently touching the ON/OFF icon on the center of the product (ref. picture 9)

AIR QUALITY INDICATOR

- 10 The appliance has an air quality sensor that analyzes the air quality.

The air quality light will show the real-time air quality through different colors of light. As shown below:

LIGHT'S COLOR	PM 2.5 (µg/m ³)	AIR QUALITY
Blue	0-15	Very Good
Green	16-35	Good
Orange	36-75	Bad
Red	>75	Very Bad

FILTER CHANGE INDICATOR

- 11 The filter change indicator will light up to remind you to change the filter (Ref. # EFFCLN2).

- When filter change indicator flicker with red light, please replace the filter and reset the filter change indicator.
- When filter change indicator stop flicker and the red light fix, please replace the filter immediately and reset the filter change indicator.

12 Filter change indicator reset operation

Press the mode icon labeled " ◇ " for 3s and filter change indicator will reset, then red light will go off.

CARE AND CLEANING

- 13 Unplug the appliance before cleaning to prevent shock or fire hazards. Use a damp cloth or a vacuum cleaner with soft brush to clean your air purifier.
- 14 The plastic part of the cabinet and top may be cleaned with an oil-free cloth or washed with a cloth dampened in a solution of warm water and mild liquid dishwashing detergent. Be sure to wring excess water from the cloth before wiping around the controls. Excess water in or around the controls may cause damage to the appliance.
- 15 Never use harsh cleaners, wax or polish when cleaning the unit.

STORAGE

- 16 If you are not planning to use the appliance for a long time, cover it with plastic or return it to its carton.

NOTE: The multi-layer filter can not be washed, it can only be replaced.

CAUTION!

Do not touch the fan blade when removing the multi-layer filter.

ERROR CODE

- 17 Fan failure error code, when fan failure occurs, the light of screen will all go off and the unit can't be operated then.
- 18 Air quality sensor failure error code, when sensor failure occurs, the light of Air quality indicator will go off and the unit can't be set on auto mode.

TROUBLESHOOTING

When fault indicators show that the system is not operating properly, perform the following check.

Commonly Asked Questions & Topics

Carry out the operations below for commonly-occurring questions or faults.

Questions or Faults	Possible Diagnosis	Corrective Steps / Reasoning
Can the filters be washed?	NO	Replace the compound filter instead of wash, the pre-filter can be wiped.
The control panel does not seem to work.	<ul style="list-style-type: none">• Power cord issue• Filter compartment issue• Fan Motor Failure	<ol style="list-style-type: none">1. Please ensure power cord is firmly attached to the unit as well as socket on the wall and then retry pressing the ON/OFF icon.2. Please reopen bottom of the unit, readjust the filter so it is centrally placed in cavity and close the bottom. Ensure bottom is firmly in place & locked and then retry operating the unit.3. If above two steps do not resolve this issue, then the unit has experienced a fan motor failure and will not operate. Please contact Electrolux authorized servicer for further troubleshooting or repairs.
The equipment emits a lot of noise.	The installation location is not at even level or the filter is not properly inserted.	Install the equipment on a level surface and re-confirm filter installation position and order.
The equipment operates normally but the outgoing air volume is significantly reduced.	The outlet might be blocked by a foreign object or the filter has not been replaced in a timely manner.	Please re-adjust the equipment installation position to ensure enough space is reserved, and confirm that filter have been replaced according to filter replacement indicator status.
If the fault encountered is not listed above, please call the Customer Service Hotline.		

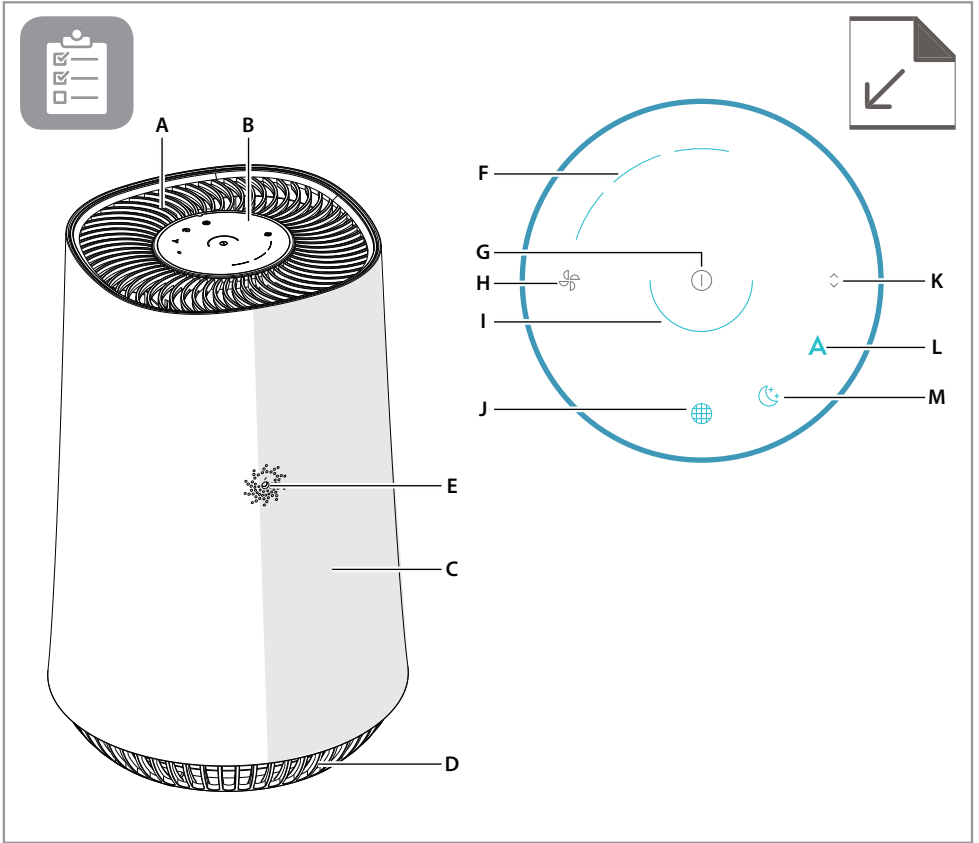

CNT FLOW A3 空氣清淨機零配件圖示說明

主機：

- A. 出風口
- B. 控制面板
- C. 機身
- D. 底座
- E. 空氣品質偵測器&電源線插孔

控制面板：

- F. 風扇速度指示燈
- G. 開/關 鍵
- H. 風扇速度設定鍵
- I. 空氣品質指示燈
- J. 濾網更換指示燈

- K. 模式選擇 & 濾網重置設定鍵
- L. 自動模式指示燈
- M. 夜間模式指示燈

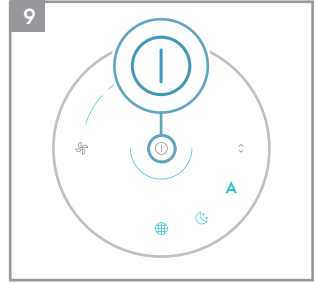
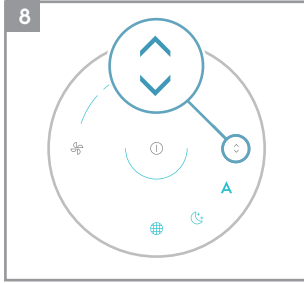
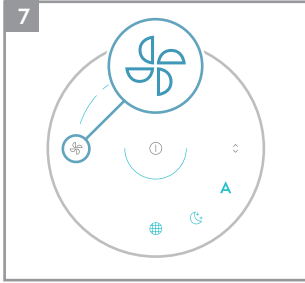
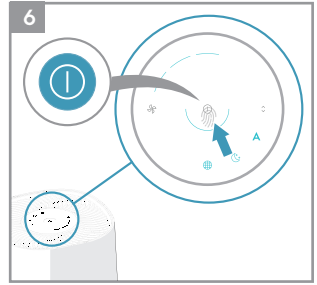
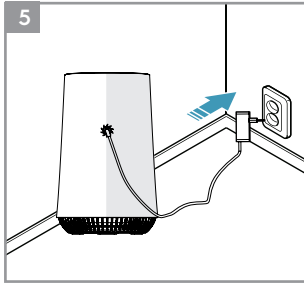
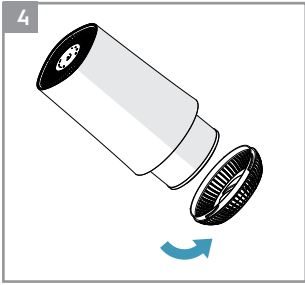
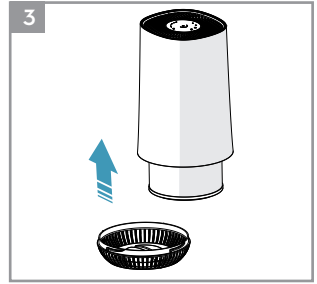
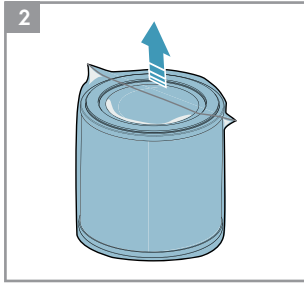
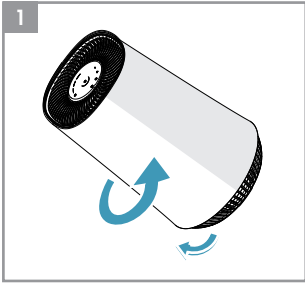

安全建議

此使用手冊為您的空氣清淨機提供具體的操作說明。請依照此使用手冊的指示說明操作此電器。這些說明並未涵蓋所有可能發生之狀況與情形。安裝、操作與保養電器時，需謹守常識與注意事項。

警告！ 避免火災或觸電。請勿使用延長線或轉接插頭。切勿從電源線上移除任何插頭插腳。只能使用本機隨附的充電變壓器

在任何情況下，請勿切斷、拆卸或繞過接地插腳。

請勿在此電器或其他任何電器周圍存放或使用汽油或其他可燃性氣體和液體。請留意產品標示上有關易燃性或其他警告之內容。請勿讓水或其他任何液體或易燃清潔劑進入電器內，以防止觸電或造成火災。

拆卸濾網時請勿觸碰風扇葉片。

兒童與弱勢群體之安全

警告！ 不適當的操作可能造成窒息、受傷或永久殘疾之風險。

此電器不適於由身體、感官或精神能力不健全、或缺乏經驗與知識的人(包括兒童)使用，除非已透過負責他們安全的人士獲得有關使用本機的監督或說明。

應監督兒童，確保他們不會將本電器當成玩具。

除非在有人監督的情況下，否則不應由兒童清潔和保養本機。3歲以下的兒童應使其遠離此電器。同時也需讓孩童遠離所有包裝。

電氣資訊

警告！避免火災或觸電。

若你不確定插座是否已充分接地或有延時保險絲或斷路器保護，請有執照的電工人員依據國家電氣規則和適用的地方法規及條例安裝適當的插座。

請勿使用延長線或轉接插頭。切勿以拉扯電源線的方式將此電器插頭從電源上拔下。請始終穩固地抓住插頭並將其從插座中直接拔出。

請勿夾住、彎折電源線或使其打結。

請勿切斷或損壞電源線。若電線線損壞，應由伊萊克斯 (Electrolux) 維修人員協助更換。如需維修，請致電給伊萊克斯客服中心。

若電源線受損，必須由製造商或客服維修人員做更換，以避免危險發生。

清潔保養前，請務必拔掉電源線以避免觸電或火災。

安全注意事項

注意！ 避免嚴重傷害或死亡。

請勿將手指或物體插入或放置於本機的排氣區域及上方格柵處。

請勿以拔掉電源線或關閉電氣箱電源的方式啟動或停止本機。

如發生故障(火花、燒焦味等)，請立即停止操作，斷開電源線並致電伊萊克斯客服中心。

請勿以濕的手操作本機，並切勿拉扯電線。

注意！ 避免受傷或損壞物件及其他財產。

請勿將氣流導向壁爐或其他熱源，以避免導致突然燃燒。

請勿攀爬本機、放置或掛置物品於本機上。

請勿將裝有液體的容器置於本機上。

若長時間不使用本機，請關閉此電器的電源。

操作此電器前請先將濾網妥善安裝完成。

請勿阻塞或覆蓋格柵、排氣區域和出風口。

確保任何電氣/電子設備與本機保持30公分以上的距離。

棄置



產品上的此標誌表示本產品含有電池，不得與普通垃圾一同處理。



產品上或包裝上的此標誌表示產品不得以一般垃圾方式處理。

若要回收此產品，請將您的產品棄置於電子/電氣設備廢品回收站或與伊萊克斯客服中心聯繫，伊萊克斯可安全、專業地對電池與電器零組件進行回收。丟棄與回收時請依據各國家對電氣設備和充電電池棄置的規定。

感謝您選擇伊萊克斯 FLOW A3空氣清淨機。

請務必使用原廠零零件和耗材，以獲得最佳效果。此產品設計時考量了環保要求，所有塑膠零件均有回收標記。

正式使用前

- 詳閱使用手冊
- 檢查所有描述的零組件是否齊全
- 特別注意安全注意事項

設定

使用前請務必先安裝濾網。

注意：安裝濾網前請先關閉電器電源

1 打開機身底座

欲打開機身底座，握住底座把手以逆時針方向轉動直到鬆脫(參照圖1)

2 取出濾網並移除濾網外袋

小心地取出濾網並拆除濾網外的塑膠包裝，並適當地將塑膠袋丟棄(參照圖2)

3 安裝濾網

將不含塑膠外包裝的濾網裝回機身(濾網的任一端都可以放入)。請留意需將濾網置於中央的位置(參照圖3)

4 關閉底座

欲關上底座，握住底部把手以順時針方向轉動底部直到穩固(參照圖4)

開始使用

注意：請確保濾網已確實地置入濾機身內，電器放置於水平地面處且電源線已穩固接上機身。

5 連接電源線

6 開啟電源

輕觸產品中央的開/關鍵即可啟動產品(參照圖6)

7 風扇速度控制

輕觸產品上的風扇圖示即可調整風扇速度。若原來的設定為自動模式，在輕觸風扇圖示後會轉為手動模式。(參照圖7)。

8 自動模式和夜間模式

欲改變自動和夜間模式，可輕觸標示"◇"的圖示。

在自動模式下，空氣清淨機會依照附近的空氣品質 (PM2.5 指數) 調整運作風速。睡眠模式下，空氣清淨機會以最低音量運作，除了夜間模式圖示外的所有指示燈皆會熄滅。

9 電源關閉

輕觸產品中央的開/關圖示便可關閉產品(參照圖9)

空氣品質指示燈

10 此產品具有空氣品質感應器可偵測空氣品質

空氣品質指示燈會透過不同燈色顯示即時空氣品質，如下圖所示：

燈號顏色	PM 2.5 (µg/m ³)	空氣品質
藍	0-15	良好
綠	16-35	普通
橘	36-75	較差
紅	>75	極差

濾網更換指示燈

11 需要更換濾網時，濾網更換指示燈將會亮起，以提醒您更換濾網(型號請參考原廠提供的資訊)。

- 濾網更換指示燈亮紅光並持續閃爍時，請更換濾網並重置濾網設定(請見12. 濾網指示燈重置操作)。
- 當更換濾網指示燈停止閃爍且紅光恆亮時，請立刻更換濾網並重置濾網設定(請見12. 濾網指示燈重置操作)。

12 濾網指示燈重新設定操作

按下模式選擇鍵 "◇" 3秒鐘，濾網更換指示燈即會被重新設定，接著紅光會消失。

保養和清潔

13 清潔前請先拔除電器插頭以防止觸電或火災。使用稍微沾濕的紙巾或吸塵器搭配軟刷清潔空氣清淨機。

14 主機的塑膠零件可用無油的乾布清潔或以稍微沾濕的布擦拭。擦拭時請注意需擰乾布上多餘的水分，以避免控制面板周圍因有過多水分導致電器損壞。

15 清潔時請勿使用強力清潔劑、打蠟或拋光。

存放

16 若您長期不使用此電器，請用塑膠袋罩住或置放於紙箱中。

備註：濾網組不能清洗，僅可更換。

注意！拆卸或更換濾網組時，請勿觸碰風扇葉片。

錯誤指令

17 當風扇故障時，螢幕燈會消失接著便無法操作此電器。

18 當空氣品質感應器故障時，空氣品質指示燈號會消失，接著將無法進行任何設定。

故障排除

當系統無法正常運作時，請參閱以下常見問題進行故障判斷與操作處理。

問題	故障現象	解決辦法
濾網可以清洗嗎？	濾網無法清洗	濾網組無法清洗但可使用乾布擦拭，如濾網更換指示燈亮起，請直接更換新的濾網組。
控制面板無法運作	<ul style="list-style-type: none">• 電線連接問題• 濾網擺放位置問題• 風扇馬達故障	<ol style="list-style-type: none">1. 請確認電源線是否穩固地連接至電器以及插座上，接著重新按開/關鍵。2. 請再次打開機身底座，重新調整濾網位置讓它位在濾網放置處的正中央並關上底座。確保底座已上鎖並穩固放置，接著重新嘗試操作此電器。3. 若上述二個步驟仍然無法解決此問題，表示此物件的風扇馬達故障導致無法運作。請聯繫Electrolux客服部門作進一步的諮詢或維修。
機器運作時發出很大的噪音	放置機器的地方不平或沒有正確安裝濾網	請在水平面處放置此電器並重新確認濾網安裝位置。
機器正常運作但輸出空氣量大量減少	出風口可能被物體擋住或沒有即時更換濾網	請重新調整機器放置位置確保已保留足夠空間，並確認已依照濾網更換指示燈的提醒更換濾網。
若故障問題不在上述清單中，請聯絡客服專線。		

客戶服務

聯繫客服部門時，請確保您已掌握了以下資訊：型號、PNC、序號。此類資訊可在產品機身標籤上找到。由於Electrolux堅持永續開發的政策，本手冊之中提及的產品規格、顏色、詳細資訊等均可能隨時更改，恕不另行通知。

以下內容僅適用於台灣市場：

有鑒於世界各國對綠色環保意識的重視，伊萊克斯依循RoHS「危害性限制物質指令」誠實標示產品化學物質含量，關於本產品的RoHS聲明書，請上伊萊克斯官網 -->「支援服務」-->「RoHS聲明書」，依產品類別及型號檢索。 <http://www.electrolux.com.tw/Support/Customer-Care/>